



Reporter's Space Flight Notepad



November 2010

STS-133 ISS-ULF5

Boeing Communications

NEWS MEDIA CONTACTS

Paula Korn
Director, Communications
Space Exploration
The Boeing Company
281-226-6005
paula.korn@boeing.com

Edmund G. Memi
Manager, External Communications
The Boeing Company
281-226-4029
edmund.g.memi@boeing.com

Susan H. Wells
Space Exploration
The Boeing Company
321-264-8580
susan.h.wells@boeing.com

Kennedy Space Center Launch Activities
(recorded message)
321-867-2525

Kennedy Space Center Newsroom
321-867-2468

Johnson Space Center Newsroom
281-483-5111

Marshall Space Flight Center Newsroom
256-544-0034

A COLOR GUIDE TO THE STS-133 REPORTER'S SPACE FLIGHT NOTEPAD



S-1

**BUILDING THE FUTURE
OF FLIGHT TOGETHER**

Gd-1

**BOEING AND THE
SPACE SHUTTLE**

I-1

HISTORY OF OV-103 - DISCOVERY

B-1

**BOEING AND THE
INTERNATIONAL SPACE STATION**

Y-1

**SPACE SHUTTLE
MISSION FACTS**

G-1

**UPCOMING SPACE SHUTTLE
MISSIONS**

BUILDING THE FUTURE OF FLIGHT TOGETHER

From their common beginnings as builders of biplanes to the exploration of space, Boeing, North American Aviation, and McDonnell Douglas share a unique aerospace heritage. Today, as one company, Boeing continues to pioneer the exploration of space.

As the Space Age dawned, each company translated its aeronautical expertise into humankind's greatest engineering feat—sending astronauts to the moon and returning them safely to Earth.

Following the success of the Apollo program, the companies continued working together in space.

When North American Rockwell began developing six space shuttles, Boeing and McDonnell Douglas joined as key partners.

McDonnell Douglas developed aft propulsion pods to control the shuttle while in orbit. It also provided structural parts for the boosters that lift shuttles into space.

Boeing modified two 747 jetliners to piggyback shuttles from landing sites in California to launch pads in Florida. One of the jumbo jets also helped test the first shuttle, which was released from the 747 at an altitude of 22,800 feet before gliding to a perfect landing.

In addition, Boeing developed the Inertial Upper Stage used by shuttle crews to boost satellites into higher orbits.

The shuttle fleet has been transporting humans and cargo to space since 1981 and has completed 130 missions. Innovations in the shuttle's design, such as a "glass cockpit," much like ones in modern airliners, improve safety and performance.

Even before the mergers, McDonnell Douglas joined the Boeing-led program to develop the International Space Station. They produced key components, including the massive solar panels, the U.S. Laboratory "Destiny," and the truss that forms the station's structural backbone.

Since then, Boeing was named NASA's lead contractor for the ISS. This includes design to delivery of U.S.-built elements. Boeing is also the major subcontractor to United Space Alliance for NASA's Space Program Operations Contract (SPOC) (replacing the original Space Flight Operations Contract or SFOC). Boeing is responsible for sustaining engineering support to operations throughout all missions. Additionally, the Boeing team provides overall shuttle system and payload integration services, and launch and mission support.

Once completed, the million-pound space station will include six laboratories and have an internal volume roughly equivalent to the passenger cabin of 1.5 747 jumbo jets. The orbital research facility celebrated its 10th anniversary of continuous human presence on Nov. 2, 2010.

BOEING AND THE SPACE SHUTTLE

In addition to manufacturing the space shuttle, The Boeing Company also plays a multitude of behind-the-scene roles integral to NASA's human space flight program.

Boeing's Space Exploration, a unit of Boeing Defense, Space & Security (BDS), which is headquartered in St. Louis, performs the work. Space Exploration is headquartered in Houston and also operates facilities in Huntington Beach, Calif.; Huntsville, Ala.; Kennedy Space Center, Fla.; and Palmdale, Calif.

Boeing is the major subcontractor to United Space Alliance (USA), NASA's prime contractor for space shuttle operations. Headquartered in Houston, Texas, United Space Alliance is one of the world's leading space operations companies. Established in 1995 as a Limited Liability Company (LLC), USA is equally owned by The Boeing Company (NYSE:BA) and Lockheed Martin Corporation (NYSE:LMT) and has employees working in Florida, Alabama, California, Washington, D.C., and Russia.

Boeing has provided design engineering and support for the shuttle fleet since the first flight in 1981. Boeing engineers are actively involved in the design and development work required to fulfill America's space exploration goals, using the existing shuttle experience and knowledge as a stepping-stone to the next space exploration vehicle.

Boeing's space shuttle work is organized into the following areas:

Ongoing Engineering Support: Boeing serves as the technical expert to NASA and USA on the design and operations of the orbiter fleet to ensure its continued safety, flight readiness, efficiency, and overall mission success. Activities range from designing new system modifications and upgrades to resolving day-to-day issues and mission anomalies.

System and Payload Integration: Boeing identifies overall shuttle system (orbiter, Space Shuttle Main Engines, external tank, and solid rocket boosters) and payload requirements during all shuttle operations phases: ground operations and checkout, ascent, on-orbit operations, reentry, landing, and ferry flight activities. It also ensures the complementary operation of shuttle system elements, payloads, and ground systems. Activities range from evaluating external structural loads, aerodynamics, heating, and guidance to developing payload support hardware.

Orbiter Maintenance and Modifications: A technical team at Kennedy Space Center supports periodic orbiter major modifications, during which each vehicle receives a comprehensive structural inspection and modifications designed to reduce program maintenance costs, expand shuttle mission capabilities, and improve operations, safety, and reliability.

Payload Ground Operations: Under the Checkout, Assembly, and Payload Processing Services (CAPPS) contract at NASA's Kennedy Space Center, Boeing performs engineering and facilities support and maintenance activities related to preparing payloads for launch in the shuttle's payload bay. Processing a human space flight payload involves complex scheduling and logistics and precise testing to ensure the payload can communicate with the orbiter and ground stations. The payloads can include scientific instruments, interplanetary spacecraft, research laboratory modules, and elements of the International Space Station. Processing activities begin years before a mission is scheduled to fly; the advance time depends on the mission's complexity.

SPACE SHUTTLE FACTS

LENGTH

System:	184.2 ft
Orbiter:	122.17 ft
External Tank:	153.8 ft
Solid Rocket Boosters (SRBs):	149.16 ft

HEIGHT

System:	76.6 ft
Orbiter:	56.58 ft

WINGSPAN

Orbiter:	78.06 ft
----------	----------

WEIGHT

Gross Liftoff:	4,500,000 lb
Orbiter Landing:	Varies, dependent upon mission

ORBITER DRY WEIGHT (WITH THREE SPACE SHUTTLE MAIN ENGINES)

Discovery:	176,419 lb
Atlantis:	176,413 lb
Endeavour:	176,056 lb
External Tank (Full):	1,668,500 lb
External Tank (Inert):	58,500 lb
SRBs (2), Each at Launch:	1,298,500 lb
SRB Inert Weight, Each:	186,800 lb

THRUST

SRBs (2):	3,300,000 lb of thrust each in a vacuum
Space Shuttle Main Engines (3):	418,000 lb of thrust each at sea level at 109 percent

CARGO BAY

Dimensions:	60-ft long, 15-ft diameter
Payloads:	Unmanned spacecraft to fully equipped scientific laboratories and ISS elements

PERFORMANCE

Payload for 160 nmi Orbit	
Due East (28.5°)—Discovery, Atlantis, or Endeavour:	54,000 lb*
High Inclination (51.6°)—Discovery, Atlantis, or Endeavour:	36,200 lb*

(weights approximate)

*Includes managers' reserve, payload attach hardware, and flight support equipment

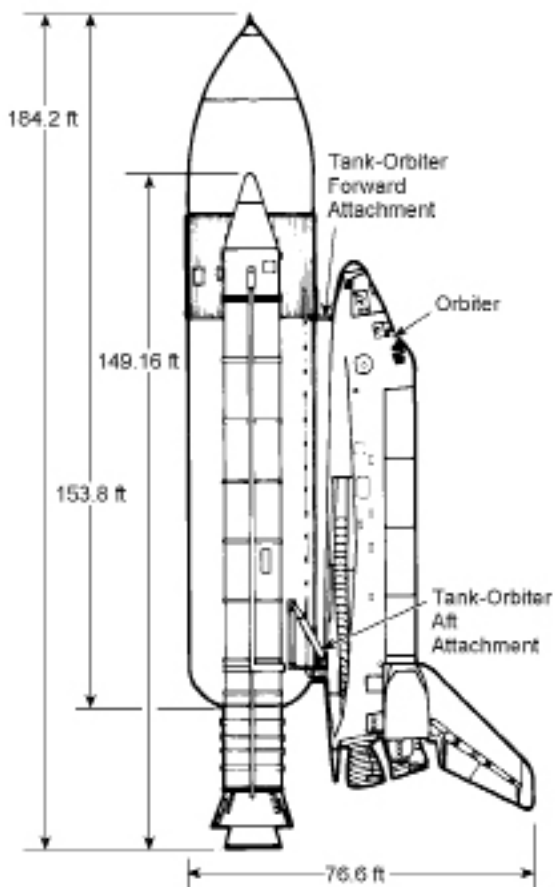
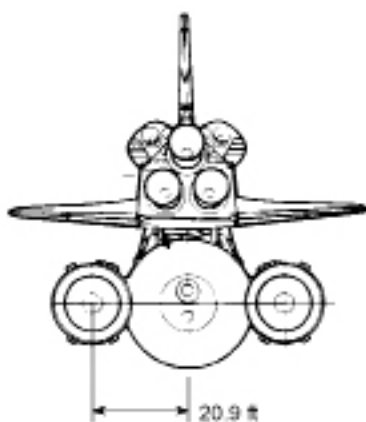

MTD 960827-5705

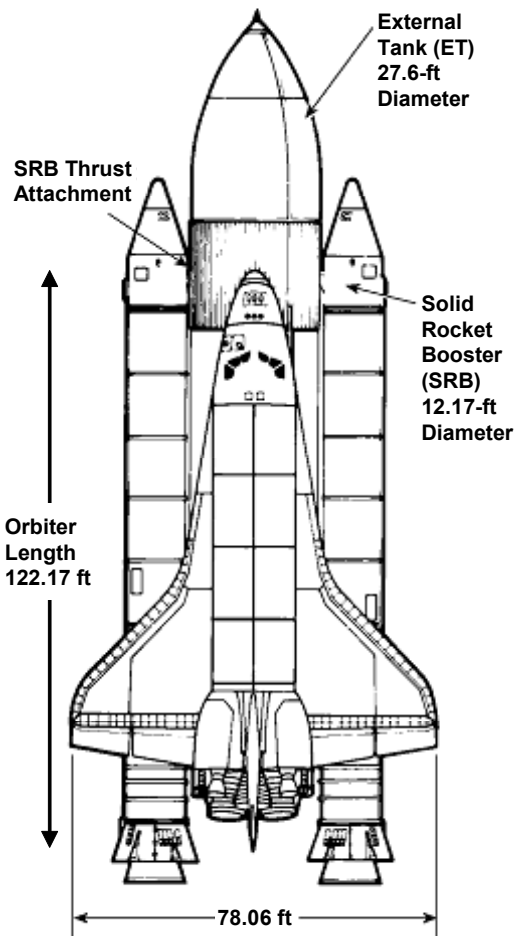
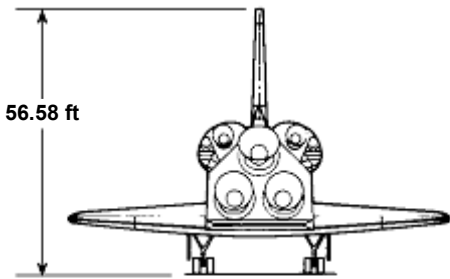

MTD 980827-5706

Space Shuttle Main Engine

The Space Shuttle Main Engines (SSMEs) are the most reliable and highly tested large rocket engines ever built. The SSMEs operate at greater temperature extremes than any mechanical system in common use today. At -423°F , the engine's fuel, liquefied hydrogen, is the second coldest liquid on Earth. When it and the liquid oxygen are combined and combusted, the temperature in the main combustion chamber is $6,000^{\circ}\text{F}$, hotter than the boiling point of iron.

One SSME generates enough thrust to maintain the flight of 2.5 Boeing 747s. Some 64,000 gallons of fuel are consumed by the main engines each minute. Even though an SSME weighs one-seventh as much as a locomotive engine, its high-pressure fuel pump alone delivers as much horsepower as 28 locomotives, while its high-pressure oxidizer pump delivers the equivalent horsepower of an additional 11 locomotives.

The SSMEs were built by Pratt & Whitney Rocketdyne, a business unit of United Technologies. Development of the engines began in the early 1970s, and the engines first flew in 1981. Since that time, the SSME remains the only reusable large rocket engine rated for human space flight in the world, with several having logged more than 20 missions. It is also the most efficient engine in the world, with an efficiency rating—or I_{sp} —of 452.3 seconds.

PERFORMANCE

BLOCK II SSME (FULL-POWER LEVEL)

MAXIMUM THRUST (109% POWER LEVEL)

At Sea Level:	418,000 lb
In Vacuum:	512,300 lb

THROTTLE RANGE: 67–109 percent

PRESSURES

Hydrogen Pump Discharge:	6,226 psia
Oxygen Pump Discharge:	7,319 psia
Chamber Pressure:	2,994 psia

SPECIFIC IMPULSE (IN VACUUM): 452.3 sec

POWER OF HIGH-PRESSURE PUMPS

Hydrogen:	69,452 HP
Oxygen:	23,551 HP

NOZZLE AREA RATIO: 69:1

WEIGHT: 7,774 lb

MIXTURE RATIO (OXIDIZER TO FUEL): 6.032:1

DIMENSIONS

Length:	168 in.
Width:	96 in.



Space Shuttle Main Engine

External Tank

The rust-colored external tank—standing taller than a 15-story building with a length of 153.8 feet and as wide as a silo with a diameter of 27.6 feet—is the single largest component of the space shuttle and is not reusable.

The ET consists of three tanks: the forward liquid oxygen tank, the aft liquid hydrogen tank, and an unpressurized intertank that unites the two propellant tanks. Weighing 58,500 lb empty and 1,668,500 lb when filled with propellants, the ET supplies more than 535,000 gallons of liquid hydrogen and oxygen to the shuttle's main engines.

The ET is primarily made of a lightweight aluminum-lithium alloy and consists of approximately 481,450 parts. If all the weld joints in the ET were laid out in a straight line, they would stretch more than half a mile. Despite its size, the aluminum skin of the tank is only 0.25-inch thick in most areas.

The ET is covered with a thermal protection system, or spray-on polyurethane-like foam insulation, which, if spread on the ground, would cover nearly two-thirds of an acre. The foam insulation on the majority of the tank is only 1-inch thick.

The closed-cell foam used on the ET was developed to keep the propellants that fuel the shuttle's three main engines at optimum temperature. It keeps the shuttle's liquid hydrogen fuel at -423°F and the liquid oxygen tank at near -297°F —even as the tank sits exposed to the Florida weather—while preventing a buildup of ice on the outside of the tank.

The retrofitted ET incorporates design and process changes to increase safety and minimize the size and probability of debris generated during launch and ascent.

The combined volume of the ET's liquid hydrogen and liquid oxygen tanks is 73,600 cubic feet—equal to the volume of nearly six 1,600-square-foot homes. Loading of the propellant takes approximately three hours.

During ascent, the ET supplies cryogenic propellants through 17-inch feedlines to the orbiter engines at a rate of 1,035 gallons per second. The ET absorbs most of the 7,000,000 lb of thrust exerted by the solid rocket boosters and the orbiter's main engines. Within 8-1/2 minutes, the orbiter has reached space, traveling at a rate of 17,500 mph. At that point, the ET separates from the orbiter and most of the tank disintegrates upon reentry into the Earth's atmosphere.

The final flight tank to come off the production line—ET-138—was delivered to NASA on June 25, 2010, and arrived at KSC on July 14. ET-122, which was refurbished after sustaining damage during Hurricane Katrina in 2005, was delivered to NASA on Sept. 16, 2010, and will fly on STS-134 in February 2011. ET-138 will be mated with boosters that will either stand by to fly with a rescue shuttle backing up the STS-134 mission, or on a final STS-135 mission tentatively scheduled for June 2011 if Congress allocates funding.

Lockheed Martin Space Systems–Michoud Operations built the space shuttle external tanks at the NASA Michoud Assembly Facility in New Orleans under a contract awarded Sept. 5, 1973, to the NASA Marshall Space Flight Center in Huntsville, Ala.



External Tank

Solid Rocket Boosters

The space shuttle's two solid rocket boosters (SRBs), the first designed for refurbishment and reuse, are also the largest solid rockets ever built and the first to be flown on a manned spacecraft.

The two SRBs generate a combined thrust of 6,000,000 lb, equivalent to 44,000,000 horsepower or 14,700 six-axle diesel locomotives or 400,000 subcompact cars.

Each of the shuttle's solid rocket boosters burns five tons of propellant per second, a total of 1,100,000 lb in 120 seconds. At liftoff, each SRB consumes 11,000 lb of fuel per second. That's two million times the rate at which fuel is burned by the average family car.

If their heat energy could be converted to electric power, two SRBs firing for two minutes would produce 2,200,000 kilowatt hours of power, enough to supply the entire power demand of 87,000 homes for a full day.

The speed of the gases exiting the nozzle is more than 6,000 mph, about five times the speed of sound or three times the speed of a high-powered rifle bullet. The combustion gases in an SRB are at a temperature of 6,100°F, two-thirds the temperature of the surface of the sun. While that temperature is hot enough to boil steel, special insulation inside the motor protects the steel case so well that the outside of the case reaches only about 130°F.

Each of the two SRBs has eight separation motors, which are small solid-fuel rocket motors designed to provide 24,000 lb of thrust each in less than 0.8 second.

The two SRBs provide 83 percent of the thrust at liftoff and during first-stage ascent.

After two minutes, at an altitude of about 24 miles, the boosters separate from the ET and continue to coast to an altitude of 44 miles before starting their descent. They descend by parachute and splash down approximately 141 miles downrange into the ocean, where they are collected for refurbishment and reuse.

ATK Aerospace Systems built the solid rocket boosters and separation motors at its facility in Promontory, Utah.

Key Components:

The Igniter: The igniter is mounted in the forward end of the SRB. It is approximately 48-inches long and 17 inches in diameter. Containing 134 lb of propellant, the igniter, when electrically activated, spreads flame down the entire length of the solid rocket booster. Approximately 0.34 second later, the space shuttle orbiter begins its ascent.

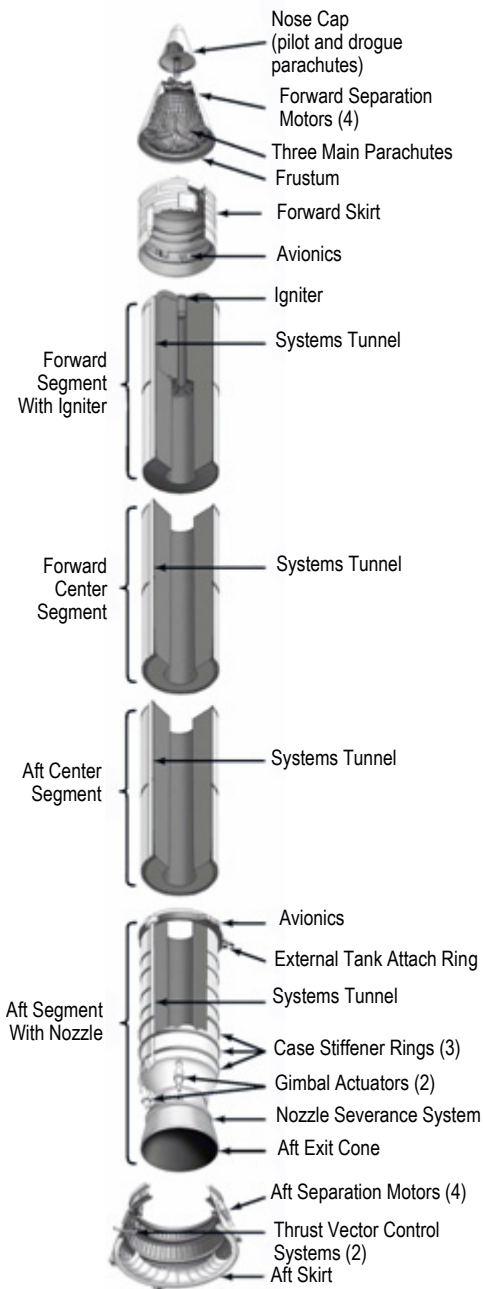

Solid Rocket Booster

The Motor Case: Consisting of 11 steel sections—nine cylinders, an aft dome, and a forward dome—joined tang to clevis and held together by load-bearing pins, the case is weld-free. Moreover, its segments are reusable—designed to perform safely and predictably for up to 20 launches.

The Propellant: When we speak of solid rocket boosters, we are referring to the propellant, which is a solid and has somewhat the same consistency as the eraser on a pencil. The solid propellant used to power the space shuttle is a composition of aluminum powder (the fuel), ammonium perchlorate (the oxidizer), HB polymer (the binder), a measured amount of iron oxide to ensure the desired propellant burn rate, and an epoxy curing agent.

The Nozzle: The nozzle, the point of exit for the hot gases of combustion, is designed to move up to 8 degrees in any direction. This is made possible by the flexible bearing. This capability to direct the booster's thrust is crucial to guiding the orbiter along its proper trajectory until the SRBs separate after liftoff.

Booster Separation Motor (BSM): Eight BSMs are used on each SRB; four motors are located on the frustum in the forward assembly, and four are located on the aft skirt. The motors are fired after two minutes of flight to jettison the boosters away from the orbiter and external tank, allowing them to continue their flight into space.

Space Shuttle Weather Launch Commit Criteria

The launch weather guidelines involving the space shuttle and expendable rockets are similar in many areas, but a distinction is made for the individual characteristics of each. The criteria are broadly conservative and ensure avoidance of possibly adverse conditions. They are reviewed for each launch.

Space shuttle weather forecasts are provided by the U.S. Air Force Range Weather Operations Facility at Cape Canaveral beginning at Launch minus three days in coordination with the NOAA National Weather Service Space Flight Meteorology Group (SMG) at Johnson Space Center in Houston. These include weather trends and their possible effects on launch day. A formal prelaunch weather briefing is held on Launch minus two days, which is a specific weather briefing for all areas of space shuttle launch operations.

Launch weather forecasts, ground operations forecasts, and launch weather briefings for the Mission Management Team and the Space Shuttle Launch Director are prepared by the Range Weather Operations Facility. Forecasts that apply after launch are prepared by SMG. These include all emergency landing forecasts and the end-of-mission forecasts briefed by SMG to the astronauts, the Flight Director, and Mission Management Team.

During the countdown, formal weather briefings occur approximately as follows:

- L-24 hr 0 min: Briefing for Flight Director and astronauts
- L-21 hr 0 min: Briefing for removal of Rotating Service Structure
- L-9 hr 00 min: Briefing for external tank fuel loading
- L-4 hr 30 min: Briefing for Space Shuttle Launch Director
- L-3 hr 55 min: Briefing for astronauts
- L-2 hr 10 min: Briefing for Flight Director
- L-0 hr 35 min: Briefing for launch and RTLS
- L-0 hr 13 min: Poll all weather constraints

The basic weather launch commit criteria on the pad at liftoff must be:

Temperature: Prior to external tank propellant loading, tanking will not begin if the 24-hour average temperature has been below 41°F.

Wind: Tanking will not begin if the wind is observed or forecast to exceed 42 knots for the next three-hour period.

Precipitation: None at the launch pad or within the flight path.

Lightning (and electric fields with triggering potential): Tanking will not begin if there is forecast to be greater than a 20 percent chance of lightning within 5 nmi of the launch pad during the first hour of tanking. There will be no launch if lightning has been detected within 10 nmi of the pad or the planned flight path within 30 minutes prior to launch or if lightning is observed and the cloud that produced the lightning is within 10 nmi of the flight path.

Clouds (types known to contain hazardous electric fields):

- Do not launch if any part of the planned flight path is through a layer of clouds any part of which within 5 nmi is 4,500-foot thick or greater and the temperature of any part of the layer is between 32°F and -4°F. Launch may occur if the cloud layer is a cirrus-like cloud that has never been associated with convective clouds, is located entirely at temperatures of 5°F or colder, and shows no evidence of containing water droplets.
- Do not launch through cumulus-type clouds with tops higher than the 41°F temperature level. Launch may occur through clouds as cold as 23°F if the cloud is not producing precipitation and all field mills within 5 nmi of the flight path and at least one field mill within 2 nmi of the cloud center read between -100 V/m and +500 V/m.
- Do not launch (1) through or within 5 nmi of the nearest edge of cumulus-type clouds with tops higher than the 14°F level; (2) through or within 10 nmi of the nearest edge of cumulus clouds with tops higher than the -4°F level.
- Do not launch if the flight path is through any nontransparent clouds that extend to altitudes at or above the 32°F level that are associated with disturbed weather producing moderate or greater precipitation, or melting precipitation, within 5 nmi of the flight path.
- Do not launch through an attached anvil cloud. If lightning occurs in the anvil or the associated main cloud, do not launch within 10 nmi for the first 30 minutes after lightning is observed, or within 5 nmi from 30 minutes to three hours after lightning is observed.
- Do not launch if the flight path will carry the vehicle
 - a. Through nontransparent parts of a detached anvil for the first three hours after the anvil detaches from the parent cloud, or the first four hours after the last lightning occurs in the detached anvil.
 - b. Within 10 nmi of nontransparent parts of a detached anvil for the first 30 minutes after the time of the last lightning in the parent or anvil cloud before detachment, or the detached anvil after its detachment.

-
-
- c. Within 5 nmi of nontransparent parts of a detached anvil for the first three hours after the time of the last lightning in the parent or anvil cloud before detachment, or the detached anvil after detachment, unless there is a field mill within 5 nmi of the detached anvil reading less than 1,000 V/m for the last 15 minutes and a maximum radar returns from any part of the detached anvil within 5 nmi of the flight path have been less than 10 dBZ (light rain) for 15 minutes.
 - Do not launch if the flight path will carry the vehicle through a thunderstorm or cumulonimbus debris cloud that is not transparent and less than three hours old. Launch may not occur within 5 nmi of these debris clouds unless (1) for 15 minutes preceding launch there is at least one working field mill within 5 nmi of the debris cloud; (2) all electric field mill readings are between -1 kV and +1 kV per meter within 5 nmi of the flight path; (3) no precipitation has been detected in the debris cloud (less than 10 dBZ by radar) within 5 nmi of the flight path.
 - Do not launch if the flight path will carry the vehicle through any cumulus cloud that has developed from a smoke plume while the cloud is attached to the plume, or for the first 60 minutes after the cumulus cloud detaches from the smoke plume.

To learn more about space shuttle weather launch criteria, visit NASA's website at:

[http://www-pao.ksc.nasa.gov/kscpao/
release/2002/92-02.htm](http://www-pao.ksc.nasa.gov/kscpao/release/2002/92-02.htm)

Shuttle Carrier Aircraft

When a space shuttle mission is nearing completion, approximately 100 people are on standby at Dryden Flight Research Center (DFRC), located inside Edwards Air Force Base (EAFB) in California, just in case landing in Florida is not an option. Approximately 40 percent of the space shuttle missions have concluded their journeys in California.

The orbiter is then ferried home to the launch complex at KSC atop a modified 747 aircraft, known as a Shuttle Carrier Aircraft (SCA).



Space shuttle Atlantis atop an SCA returns to KSC.

At EAFB, the space shuttle hanger, located near the Mate-Demate Device (MDD), is a single-bay, 25,000-square-foot structure that is 170-feet deep, 140-feet wide, and 80-feet high. A concrete tow-way connects the space shuttle hanger and the MDD with the aircraft ramp at the main Dryden complex and with the taxiway extending onto the EAFB flightline and runway network.

The orbiter must be placed on top of the SCA by the MDD, a large gantry-like structure that hoists the orbiter off the ground for postflight servicing or mates it with the SCA for the ferry flight. Boeing has developed top-level procedures, specifications, and drawings for attaching the orbiter on top of the 747 using the MDD.

The MDD facility consists of two 100-foot towers with stationary work platforms at the 20-, 40-, 60-, and 80-foot levels on each tower and a horizontal structure mounted at the 80-foot level between the two towers. The horizontal unit cantilevers 70 feet out from the main tower units and controls and guides a large lift beam that attaches to the orbiter to raise and lower it.

Three large hoists are used to raise and lower the lift beam. Two of the hoists are connected to the aft portion of the lift beam, and one hoist is attached to the beam's forward section. The three hoists operate simultaneously in the hoisting process. Operating together, the total lifting capacity of the three units is 240,000 lb.

The process of raising the orbiter, sliding in the 747, and then lowering the orbiter onto the aircraft is a slow one. Three struts with associated interior structural strengthening protrude from the top of the fuselage on which the orbiter is attached, two aft and one in front, similar to the attach points used for the external tank. The team also inspects the landing gear, external tank disconnect doors, payload bay doors, drag chute, and the airframe.



At EAFB, the SCA is towed beneath the orbiter, suspended in the MDD.

Ferry flight-unique hardware consists of a 10,000-lb aerodynamic tailcone installed over the orbiter's main engine nozzles, carrier panels, external tank ferry flight doors, cap and plug sets, auxiliary power unit vent drain line covers, and other items that are installed on the orbiter. The tailcone and vertical stabilizers on the tail reduce aerodynamic drag and smooth out the airflow over the orbiter during the ferry flight.

The 747 has been extensively modified, all for the sake of reducing weight. The passenger area has been stripped of all galleys, carpeting, and even some inside temperature ductwork. The plane still weighs more than 300,000 lb, and the orbiter atop weighs 176,000 lb or more, depending on any onboard payload.

During a normal flight, the SCA might use 20,000 lb of fuel an hour; with an orbiter on its back, that number doubles.

Each time NASA needs to ferry an orbiter from California to Florida, it costs the agency approximately \$1.8 million. The vast majority of that cost is fuel for the 747, which burns one gallon for every plane length it flies.

During the flight, only four people are on board: the crew of two pilots and two engineers. The small team forming SCA crews includes specially trained pilots and flight engineers who are former military aviators qualified to fly several types of aircraft.

In addition, a "Pathfinder" aircraft, usually a U.S. Air Force cargo plane, flies 100 miles ahead of the SCA, carrying weather officers and space shuttle personnel from KSC. Also on board is an experienced SCA pilot, whose expertise helps the ferry flight crew keep to the safest route.

Flying with the additional drag and weight of the orbiter imposes altitude and fuel restrictions as well. The range is reduced to 1,000 nmi compared to an unladen range of 5,500 nmi, requiring an SCA to stop several times to refuel on the 2,500-mile cross-country flight. The SCA has an altitude ceiling of 15,000 feet and a maximum cruise speed of Mach 0.6 with the orbiter attached.

Perhaps the biggest challenge the crew faces during a ferry flight is the weather. The orbiter tiles cannot be exposed to moisture, turbulence, or temperatures below 15°F, and these restrictions determine the SCA's flight path and altitude. To meet these conditions in the winter months, the SCA sometimes flies as low as 10,000 feet.



An orbiter atop an SCA is towed toward the MDD at the Shuttle Landing Facility at KSC. Once underneath the device, a hoist will lift the orbiter from the back of the SCA and place it on the ground.

Shuttle Amazing Facts

The space shuttle has more than 2,500,000 parts, including about 170 miles of wire, more than 1,060 plumbing valves and connections, about 1,440 circuit breakers, and more than 24,000 insulating tiles and thermal blankets. It is the most complex machine ever built.

Although it weighs more than 4,500,000 lb at launch, the space shuttle accelerates from zero to about nine times as fast as a rifle bullet, or more than 17,500 mph, to attain Earth orbit in less than nine minutes, during which time more than 3,500,000 lb of propellants are completely consumed. The shuttle breaks the sound barrier 52 seconds into flight.

The orbiter, both the brains and heart of the Space Transportation System, is about the same size as a Boeing 737 aircraft. The cargo bay measures 60 feet by 15 feet in diameter and can carry cargo up to 65,000 lb.

The shuttle's 24,000 individual tiles are made primarily of pure sand silicate fibers, mixed with a ceramic binder. Incredibly lightweight and about the same density as balsa wood, they dissipate the heat so quickly that a white-hot tile with a temperature of 2,300°F can be taken from an oven and held in bare hands without injury.

Two orbital maneuvering system (OMS) engines, mounted on either side of the upper aft fuselage, provide thrust for major orbital changes. For more exacting motions in orbit, 44 small rocket engines, clustered on the shuttle's nose and on either side of the tail, are used. Together, they are known as the reaction control system.

Temperatures experienced by the space shuttle range from as low as -250°F in space to as high as 3,000°F during re-entry into the Earth's atmosphere while traveling more than 17,000 mph.

At 149-feet, 1.6-inches tall, the solid rocket booster is only two feet shorter than the Statue of Liberty, but each 700-ton loaded booster weighs more than three times as much as the famous statue. The SRBs, which burn solid propellant, provide more than 83 percent of the space shuttle's thrust during the first two minutes of ascent. The two SRBs generate a combined thrust of 5.3 million lb, equivalent to 44 million horsepower.

The 15-story-tall, rust-colored external tank is the only shuttle element that isn't reused. Despite its size, the aluminum skin of the tank is only 0.125-inch thick in most areas. It feeds more than 500,000 gallons of fuel to the shuttle's main engines during launch at the rate of more than 1,000 gallons per second.

If the shuttle main engines pumped water instead of fuel, they would drain an average-size swimming pool in 25 seconds.

HISTORY OF OV-103 — DISCOVERY

Discovery, the third orbiter to become operational at Kennedy Space Center, was named after one of two ships that were used by the British explorer James Cook in the 1770s during voyages in the South Pacific that led to the discovery of the Hawaiian Islands.

Cook also used Discovery to explore the coasts of southern Alaska and northwestern Canada. During the American Revolutionary War, Benjamin Franklin made a safe conduct request for the British vessel because of the scientific importance of its research.

In the day-to-day world of shuttle operations and processing, space shuttle orbiters go by a more prosaic designation. Discovery is commonly referred to as OV-103, for Orbiter Vehicle 103.

Discovery is now the oldest orbiter in service and has performed both research and International Space Station assembly missions. It has flown 38 flights, completed 5,247 orbits, and has spent 352 days in orbit.

Construction of the orbiter Discovery began in August 1979 in Palmdale, Calif. Discovery benefited from lessons learned in the construction and testing of orbiters Enterprise, Columbia, and Challenger. At rollout, its weight was some 6,870 pounds less than Columbia's, with an empty weight of 151,419 pounds and 176,419 pounds with main engines installed.

Discovery was rolled out from the Palmdale facility on Oct. 16, 1983; transported over land to Edwards Air Force Base on Nov. 5; and delivered to Kennedy Space Center on Nov. 9.



OV-103—Discovery—is rolled out at the Boeing Palmdale facility on Oct. 16, 1983. Waiting on the stage was the crew of its first mission, STS-41-D.

Space shuttle Discovery lifted off on its maiden voyage on Aug. 30, 1984, on mission STS-41-D, to deploy three satellites: Satellite Business Systems (SBS-D), SYNCOM IV-2 (also known as Leasat-2, short for Leased Satellite), and Telstar 3-C.



Space shuttle Discovery lifts off on its first mission, STS-41-D.

Discovery is the orbiter fleet leader, having flown more flights than any other orbiter in the fleet. Discovery has been chosen twice as the Return to Flight orbiter, first in 1988 as the STS-26 Return to Flight orbiter after the 1986 Challenger disaster, and then for the twin Return to Flight missions of STS-114 in July 2005 and STS-121 in July 2006 after the 2003 Columbia disaster.

Discovery was the shuttle that launched the Hubble Space Telescope in 1990, as well as flying the second and third Hubble service missions.



The Hubble Space Telescope is held by the shuttle's remote manipulator system in deploy position above Discovery's payload bay on mission STS-31 in 1990.

Discovery also launched the Ulysses probe and three Tracking and Data Relay Satellites (TDRS). In addition, Discovery carried Project Mercury astronaut John Glenn, who was 77 at the time, back into space during shuttle mission STS-95 on Oct. 29, 1998, making him the oldest human being to venture into space.

Discovery has gone through two overhauls of scheduled Orbiter Maintenance Down Periods (OMDPs) during its operational history. Discovery arrived at Palmdale in September 1996 for OMDP-1. During that nine-month visit, a complete structural inspection was conducted, and 78 modifications were made, including installation of a drag chute, a fifth set of cryogenic tanks, and an external airlock to support missions to the ISS.



Discovery at the Boeing Palmdale facility during OMDP-1.

In 2002, Discovery again arrived at Palmdale for OMDP-2, which was completed after more than two years. The modifications included 99 upgrades and 88 special tests, including a number of changes to make it safer for flight. Each wing contains sensors that are able to take 20,000 samples per second and detect micrometeorite or other impacts. There are 22 temperature sensors and 66 accelerometers. Discovery also has a 50-foot inspection boom that can be used to check Discovery's underside for damage.

When space shuttle Discovery lands after completing mission STS-133, it will conclude a journey covering three decades and more than 128 million miles. During Discovery's 39 missions, it has deployed 31 satellites, docked with the Mir space station once, and docked with the ISS 12 times.

NASA has offered Discovery to the Smithsonian Institution's National Air and Space Museum, for public display and preservation as part of the national collection. Discovery will replace space shuttle Enterprise in the display at the Steven F. Udvar-Hazy Center near Dulles International Airport in Virginia.



Photo by Larry Tanner/United Space Alliance

Space shuttle Discovery, mounted atop a mobile launch platform carried by a crawler transporter, during its 3.4-mile journey from the Vehicle Assembly Building to launch pad 39A on Sept. 20, 2010. Hundreds of shuttle workers and their families turned out to cheer the shuttle on during its last launch pad trek.

Final ISS Configuration

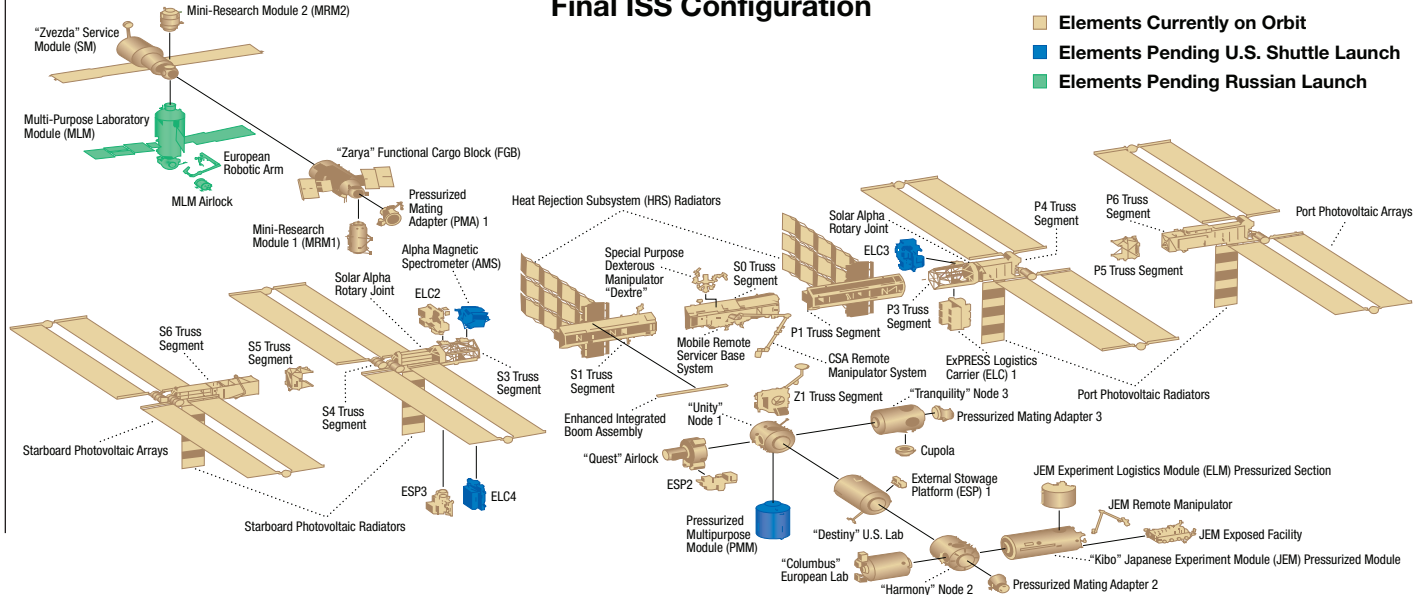

BOEING AND THE INTERNATIONAL SPACE STATION

In 1993, NASA selected Boeing as the prime contractor for the International Space Station (ISS). As the prime contractor, Boeing directed an industry team comprising major U.S. aerospace companies and hundreds of smaller subcontractors. This collaboration guided the construction, assembly, and utilization of the space station.

The National Aeronautic Association (NAA) awarded the prestigious 2009 Collier Trophy, which recognizes the greatest achievements in aeronautics or astronautics in the United States, to the International Space Station Program (ISSP) in 2010.

Exceeding the size of a football field, the ISS is the largest international space venture ever undertaken. Today, Boeing continues to provide sustaining engineering, payload integration, mission operation, and maintenance support, to ensure maximum utilization of the station as it nears assembly-complete.

Boeing Development and Production

Boeing produced the space station's pressurized U.S. modules, including Unity (Node 1), the U.S. Destiny Laboratory, and Quest (the ISS joint airlock). This production work was completed in Huntsville, Ala. The Huntsville team also designed the station's environmental control and life support systems. Their contributions continued with the design of a common berthing mechanism. Used by all non-Russian pressurized modules, it allows the transfer of racks between non-Russian pressurized elements. The device is the largest berthing mechanism of its kind.

Boeing also developed the end-to-end electrical power system architecture for the ISS. The system provides all user and housekeeping electrical power and is capable of expansion to accommodate new ISS components.

Flexible and deployable, solar array wings provide power to the space station. Each wing consists of two blanket assemblies covered with solar cells. Following deployment, each pair of blankets is supported by an extendable mast. This work was performed in Canoga Park, Calif., by Boeing's former Rocketdyne division.

Also in California, the Huntington Beach team made a variety of contributions to the ISS program. They developed and built the station's pre-integrated truss structure, pressurized mating adapters, and mobile transporter. They also led the development efforts of several subsystems, such as communications and tracking, command and data handling, and thermal control.

Boeing Current Operations

Boeing is responsible for leading efforts on the U.S. segments of the station. These segments include the U.S.

Destiny Laboratory, interconnecting nodes and structures, the ISS power, data management, environmental control, and life support systems, as well as other critical hardware and software devices. In addition to designing and building all the major U.S. elements, Boeing is responsible for the successful integration of any new hardware and software, including that from international partners. Boeing verification teams effectively combine these ISS components to ensure the successful operation of one of the most complex scientific collaborations to date. Fulfilling its duties as prime contractor, Boeing also assembles and designs payload racks, cargo carriers, internal thermal controls, internal audio-video systems, a secondary power subsystem, as well as other essential subsystems.

On March 5, 2010, Boeing officially turned over the U.S. on-orbit segments of the ISS to NASA with the signing of government form DD-250 at the conclusion of an Acceptance Review Board meeting in Houston, Texas. Often referred to as “handing over the keys,” the DD-250 is equivalent to a final bill of sale that formally transfers ownership. Through the review board, NASA and Boeing verified the successful delivery, assembly, integration, and activation of all hardware and software required by contract.

In September 2010, NASA awarded Boeing a five-year extension to a contract covering engineering work on the ISS. The extension began with the new federal fiscal year on Oct. 1, 2010. Boeing will provide engineering oversight of maintenance for hardware and software on the U.S. part of the space station and for some hardware and software available to international partners. The work will be done at NASA facilities in Houston, Texas; Cape Canaveral, Fla.; and Huntsville, Ala.; and at Boeing sites in Houston, Huntsville, and Huntington Beach, Calif. This work sets the stage to keep the space station operating until 2020 and possibly through 2028.

The Value of ISS

As the world’s only orbiting research facility, the ISS provides a unique microgravity environment that cannot be replicated in ground laboratories. From astrobiology to materials science, the research facilities aboard the station are teeming with opportunities for scientific advancement and innovation.

ISS Program Benefits:

- The ISS is the only platform for learning how to live and work in space for extended periods of time.
- Expedition crews conduct daily science experiments across a wide variety of fields, including human physiology, gravitational biology, physical sciences, and Earth observation.
- A scientific collaboration among 15 countries, the ISS serves as a beacon of international cooperation and human accomplishment. The successful implementation, assembly, and operation of the station promotes

future space exploration partnerships and positive diplomatic relations.

- From engineering technologies to decision-making processes, the ISS provides the foundation for future long-duration space missions. It is the bridge to the next era of manned space exploration.
- The ISS program aims to inspire students of all ages to pursue science, technology, engineering, and mathematics (STEM disciplines). Student engagement includes on-orbit question-answer sessions with astronauts, basic science demonstrations, and the opportunity for students to fly and conduct their own ISS experiments.

A New National Laboratory

With the implementation of the 2005 NASA Authorization Act, the U.S. components of the ISS have been designated a National Lab. According to the Act, this designation will “increase the utilization of the ISS by other federal entities and the private sector.” NASA will continue its research agenda, with the addition of new National Lab partners, to maximize return on one of our greatest scientific assets. As the only national laboratory of its kind, the ISS provides a unique research facility to accommodate the research needs of both NASA and other National Lab users.

Research on ISS

Space investigators from industry, academia, and government can take advantage of the diverse state-of-the-art facilities carried aboard the orbiting complex. In addition, “remote telescience”—meaning an interactive set of data and video links—offers the ability for scientists on the ground to have a direct connection with their experiments on orbit.

A vigorous research agenda is well underway aboard the ISS, yielding a steady stream of findings that increase our understanding of both space and Earth-bound human systems. For example, studies related to bone density loss associated with long-duration space flight are applicable to studies of osteoporosis and aging.

Aside from NASA’s research schedule, initial National Lab users are also reaping the benefits of a microgravity research environment. Even in its fledging stage, the National Lab program has enabled advancements in astrobiology and virulence studies. Such promising results may lead to the development of vaccines for viruses like Salmonella. Scientific results from early space station research are being published every month along with those of current National Lab participants.

New technologies needed for future exploration missions—including new materials, life support systems, and environmental monitoring—are also being tested on the station. It is the essential building block to continue our

space exploration agenda and enables the discovery of worlds beyond our own.

General Science Overview

Astronauts have conducted basic research aboard the ISS since 2000, but the addition of new laboratory facilities and a six-person crew are greatly expanding the station's science capacity and broadening the scope of experiments the complex hosts.

Station residents now spend an average of about 40 crew-hours per week on research, up from fewer than 15 hours before the expansion to a six-person crew in May 2009.

The station's NASA, European, and Japanese labs are now home to 21 refrigerator-sized internal experiment racks.

Eighteen power and data ports for large external experiments have already been delivered to the complex's U.S., European, and Japanese segments. Ten sites are available on Japan's Kibo laboratory module Exposed Facility, and four locations each are located on the European Space Agency's Columbus lab and two ExPRESS logistics carriers brought to the station during space shuttle mission STS-129. Two more ExPRESS carriers are scheduled for launch to the station, adding four additional experiment sites.

Upon completion, the ISS will provide eight research racks, 16 system racks, and 10 stowage racks that support NASA and National Lab users' research objectives. Key station research for ongoing expeditions will be conducted in the following disciplines:

- **Human Research and Counter Measure Development**—Astronauts will be able to take full advantage of three Human Research Facilities (HRFs) and numerous accompanying physiological modules aboard the station to gain understanding of microgravity effects on the human body.
- **Technology Development**—From Materials International Space Station Experiment (MISSE) to Vehicle Cabin Atmosphere Monitor (VCAM), researchers are currently analyzing results that can lead to the development of advanced alloys, computer networks, and monitoring systems for future exploration and ground-based innovation.
- **Microgravity Biological Sciences**—Cellular analysis in a microgravity environment is a captivating new research field made possible with the state-of-the-art ISS research facilities. The altered behavior of cells in space has the potential to lead to astounding medical breakthroughs on Earth. Current and future station inhabitants use station amenities like the Transgenic Arabidopsis Gene Expression System (TAGES), Biological Laboratory in Columbus (BioLab), and Microgravity Experiment Locker/Incubator (MERLIN) to investigate both plant and animal cells and expedite biological advancements in ground laboratories.

-
-
- **Earth Observation and Monitoring**—With equipment like Agricultural Camera (AgCam), astronauts can transfer automated imagery to ground researchers within two days. This provides scientists vegetative insight, as well as the data necessary to monitor the availability of natural resources and our environmental impact. The Crew Earth Observation (CEO) program allows astronauts to take photos of variable events to supplement ground investigations. Dynamic events have included fires, floods, and volcanic eruptions.

Expedition 24 and 25 Science Overview

The Expedition 24 and 25 missions continue the transition from assembling the International Space Station to using it for continuous scientific research. Nearly 150 operating experiments in human research, biological and physical sciences, technology development, Earth observation, and educational activities are being conducted aboard the station, including several pathfinder investigations under the auspices of the station's role as a U.S. National Laboratory.

In the past, assembly and maintenance activities dominated the available time for crew work. But as completion of the orbiting laboratory nears, additional facilities, and the crew members to operate them, have enabled a measured increase in time devoted to research as a national and multinational laboratory.

Among the National Laboratory Pathfinder (NLP) investigations are the latest experiments in the NLP Vaccine series, which will follow up on recent discoveries about how the infectious nature of some germs can be controlled. The NLP Vaccine research is aimed at developing vaccines against microbial pathogens, with results already obtained targeting Salmonella bacteria that cause diarrhea.

The work of more than 400 scientists, this research has been prioritized based on fundamental and applied research needs established by NASA and the international partners—the Canadian Space Agency (CSA), European Space Agency (ESA), Japan Aerospace Exploration Agency (JAXA), and Russian Federal Space Agency (RSA).

Managing the international laboratory's scientific assets, as well as the time and space required to accommodate experiments and programs, from a host of private, commercial, industry, and government agencies nationwide, makes the job of coordinating space station research critical.

Teams of controllers and scientists on the ground continuously plan, monitor, and remotely operate experiments from control centers around the globe. Controllers staff payload operations centers all over the world, effectively providing for researchers and the station crew around the clock, seven days a week.

State-of-the-art computers and communications equipment deliver up-to-the-minute reports about experiment facilities and investigations between science outposts across the United States and around the world. The payload operations team also synchronizes the payload timelines among international partners, ensuring the best use of valuable resources and crew time.

The control centers of NASA and its partners are:

- NASA Payload Operations Center, Marshall Space Flight Center in Huntsville, Ala.
- RSA Center for Control of Spaceflights ("TsUP" in Russian) in Korolev, Russia
- JAXA Space Station Integration and Promotion Center (SSIPC) in Tsukuba, Japan
- ESA Columbus Control Center (Col-CC) in Oberpfaffenhofen, Germany
- CSA Payloads Operations Telesciences Center, St. Hubert, Quebec, Canada

NASA's Payload Operations Center serves as a hub for coordinating much of the work related to delivery of research facilities and experiments to the space station as they are rotated in and out periodically when space shuttles or other vehicles make deliveries and return completed experiments and samples to Earth.

The payload operations director leads the POC's main flight control team, known as the "cadre," and approves all science plans in coordination with Mission Control at NASA's Johnson Space Center in Houston, the international partner control centers, and the station crew.

Expeditions 24 and 25 continue the tradition of scientific activities aboard the ISS that began with Expedition 1 in 2000. Myriad activities include experiments that require crew support, as well as automated experiments that are ongoing without crew efforts.

U.S. experiments include:

Evaluation of Maximal Oxygen Uptake and Submaximal Estimates of VO₂max Before, During, and After Long-Duration International Space Station Missions (VO₂max) documents changes in maximum oxygen uptake for crew members on board the station on long-duration missions.

Spinal Elongation and Its Effects on Seated Height in a Microgravity Environment (Spinal Elongation) provides quantitative data about the amount of change that occurs in the seated height due to spinal elongation in microgravity.

Amateur Radio on the International Space Station (ARISS) allows crew aboard the ISS, with the help of Amateur Radio Clubs and ham radio operators, to speak directly with groups of the general public, showing teachers, students, parents, and communities how amateur radio can motivate students' learning about science and technology.

Crew Earth Observations (CEO) takes advantage of having the crew in space to observe and photograph natural and human-made changes on Earth. The photographs record the Earth's surface changes over time, along with dynamic events such as storms, floods, fires, and volcanic eruptions. These images provide researchers on Earth with key data to better understand the planet.

Psychomotor Vigilance Self-Test consists of a five-minute reaction time task that allows crew members to monitor the daily effects of fatigue on performance while on the ISS. The experiment provides objective feedback on neurobehavioral changes in attention, psychomotor speed, state stability, and impulsivity while on ISS missions, particularly as they relate to changes in circadian rhythms, sleep restrictions, and extended work shifts.

The Nutritional Status Assessment is the most comprehensive in-flight study done by NASA to date of human physiologic changes during long-duration space flight. It includes measures of bone metabolism, oxidative damage, nutritional assessments, and hormonal changes. This study will impact both the definition of nutritional requirements and development of food systems for future space exploration missions. This experiment will also help to understand the impact of countermeasures (exercise and pharmaceuticals) on nutritional status and nutrient requirements for astronauts.

The Biological Specimen Repository is a storage bank that is used to maintain biological specimens over extended periods of time and under well-controlled conditions. Biological samples from the ISS, including blood and urine, are collected, processed, and archived during the preflight, in-flight, and postflight phases of ISS missions. This investigation has been developed to archive biosamples for use as a resource for future space flight-related research.

Sleep-Wake Actigraphy and Light Exposure During Space Flight—Long examines the effects of space flight and ambient light exposure on the sleep-wake cycles of the crew members during long-duration stays on the space station.

Vehicle Cabin Atmosphere Monitor (VCAM) identifies gases that are present in minute quantities in the ISS breathing air that could harm the crew's health. If successful, instruments like VCAM could accompany crew members during long-duration exploration missions.

HREP—the Hyperspectral Imager for the Coastal Ocean (HICO) and Remote Atmospheric and Ionospheric Detection System (RAIDS) Experiment Payload—operates a visible and near-infrared (VNIR) maritime hyperspectral imaging (MHSI) system to detect, identify, and quantify coastal geophysical features from the ISS. The experiment provides atmospheric scientists with a complete description of the major constituents of the thermosphere (layer of

the Earth's atmosphere) and ionosphere (uppermost layer of the Earth's atmosphere) global electron density profiles at altitudes between 100 to 350 kilometers.

Microgravity Acceleration Measurement System (MAMS) and Space Acceleration Measurement System-II (SAMS-II) measure the ISS vibrational accelerations during specific periods of operations. MAMS and SAMS-II further the understanding of accelerations resulting from physical disturbances on the ISS. MAMS and SAMS-II also help characterize accelerations that may affect ISS experiments.

International partner experiments include:

The Effect of Long-term Microgravity Exposure on Cardiac Autonomic Function by Analyzing 24-hours Electrocardiogram (BioRhythms), sponsored by Japan Aerospace and Exploration Agency (JAXA), examines the effect of long-term microgravity exposure on cardiac autonomic function by analyzing 24-hour electrocardiograms.

Mycological Evaluation of Crew Exposure to ISS Ambient Air (Myco), sponsored by JAXA, evaluates the risk of microorganisms via inhalation and adhesion to the skin to determine which fungi act as allergens on the ISS.

Japan Aerospace Exploration Agency–Education Payload Observation (JAXA–EPO) aims to generate interest in microgravity research and human space flight. Activities include educational events and artistic activities with astronauts on orbit.

Sun Monitoring on the External Payload Facility of Columbus (Solar), sponsored by the European Space Agency (ESA), is a monitoring observatory that measures solar spectral irradiance. Apart from scientific contributions for solar and stellar physics, the knowledge of the solar energy irradiance into the Earth's atmosphere and its variations is of great importance for atmospheric modeling, atmospheric chemistry, and climatology. Solar consists of three instruments complementing each other to allow measurements of the solar spectral irradiance throughout virtually the whole electromagnetic spectrum, from 17 nanometers to 100 micrometers, in which 99% of the solar energy is emitted. The scientific instruments are SOLar Variable and Irradiance Monitor (SOVIM), which covers near-ultraviolet, visible, and thermal regions of the spectrum (200 nanometers to 100 micrometers); SOLar SPECTral Irradiance Measurements (SOLSPEC), which covers the 180-nanometer to 3,000-nanometer range with high spectral resolution; and SOLar Auto-Calibrating Extreme UV/UV Spectrometers (SOLACES), which measures the EUV/UV spectral regime (17 nanometers to 220 nanometers) with moderate spectral resolution.

Monitor of All-sky X-ray Image (MAXI) is an externally mounted experiment attached on the Japanese Experiment Module (JEM) Exposed Facility. MAXI consists of highly

sensitive X-ray slit cameras for the monitoring of more than 1,000 X-ray sources in space over an energy band range of 0.5 to 30 keV.

Passive Dosimeter for Lifescience Experiment in Space (PADLES), sponsored by JAXA, uses passive and integrating dosimeters to detect radiation levels on board the ISS. These dosimeters are located near the biological experiment facilities and on the end of the JEM. The dosimeters measure absorbed doses, equivalent doses, and linear energy transfer (LET) distributions.

Space Environment Data Acquisition Equipment–Attached Payload (SEDA-AP), sponsored by JAXA, measures the space environment (neutrons, plasma, heavy ions, high-energy light particles, atomic oxygen, and cosmic dust) in ISS orbit and environmental effects on materials and electronic devices to investigate the interaction with and from the space environment at the JEM EF. At the same time, it conducts on-orbit verification of Attached Payload Bus (APBUS) technology, which furnishes necessary functions when mounted on the JEM EF.

SOdium LOading in Microgravity (SOLO), sponsored by ESA, is a continuation of extensive research into the mechanisms of fluid and salt retention in the body during bed rest and space flights. Astronauts participate in two metabolically controlled study phases of five days each. Subjects follow a diet of constant either low or normal sodium intake, fairly high fluid consumption, and isocaloric nutrition.

Superconduction Submillimeter-wave Limb-emission Sounder (SMILES), sponsored by JAXA, is aimed at global mappings of stratospheric trace gases by means of the most sensitive submillimeter receiver. Such sensitivity is ascribed to a superconductor-insulator-superconductor (SIS) mixer, which is operated at 4.5 K in a dedicated cryostat combined with a mechanical cooler.

On the Internet: For fact sheets, imagery, and more on Expedition 24/25 experiments and payload operations, visit:

http://www.nasa.gov/mission_pages/station/science/index.htm

For general information about science on the ISS, visit:

http://www.nasa.gov/mission_pages/station/science/index.htm

ISS FACTS

(weights approximate)

Measurements (at completion)

Solar Array Wingspan:	356.51 ft (108.67 m) (port to starboard)
Length:	170.6 ft (52.0 m) (pressurized section)
Integrated Truss Length:	323.25 ft (98.6 m)
Mass (weight):	816,349 lb (370,290 kg)
Operating Altitude:	220 nmi average (407 km)
Inclination:	51.6 deg to the equator
Atmosphere Inside:	14.7 psi (101.36 kilopascals), same as Earth
Pressurized Volume:	31,509 ft ³ (892 m ³) (assumes a Progress and two Soyuz vehicles are docked to station)
Crew Size:	Six
Speed:	17,500 mph
Robotic Arms:	55-ft robot arm assembly that can lift 220,000 lb and is used for assembly of main ISS; 30-ft robotic arm based on Kibo and used to move and deploy experiments on the Japanese External Facility. In addition, the JEM Small Fine Arm and the Special Purpose Dexterous Mani- pulator can be used by the main arms for more delicate tasks.
Power Generation:	84-120 kilowatts (usable)

The Partners

The ISS is a partnership among five space agencies from the United States, Canada, multiple European states, Japan, and Russia.

ISS Configuration as of Mission STS-132/ISS-ULF4
(May 2010)

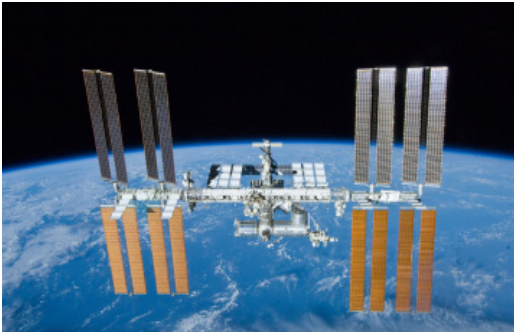

Final ISS Configuration

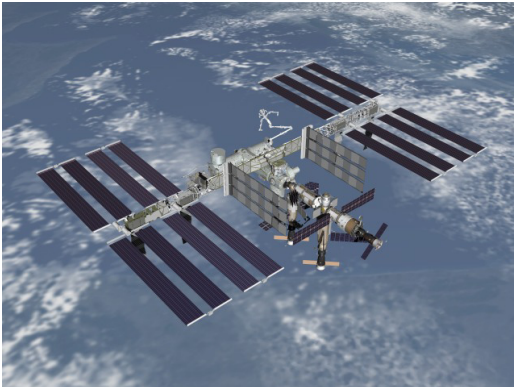

ISS Element Statistics (as of October 2010)

<u>Module</u>	<u>Weight (lb)</u>	<u>Weight (kg)</u>	<u>Launched</u>
Zarya	50,419	22,870	11/20/98
Node 1 "Unity"	24,711	11,209	12/04/98
PMA-1	3,504	1,589	12/04/98
PMA-2	3,033	1,376	12/04/98
Zvezda	53,267	24,162	07/12/00
Z1 Truss	19,227	8,721	10/11/00
PMA-3	2,575	1,168	10/11/00
Soyuz	15,762	7,150	
P6 Truss	34,919	15,839	11/30/00
U.S. Lab "Destiny"	53,602	24,313	02/07/01
External Stowage Platform 1	145	66	03/08/01
Canadarm2	3,311	1,502	04/19/01
Joint Airlock "Quest"	20,831	9,449	07/12/01
Progress	15,200	6,895	
Pirs	7,150	3,243	09/15/01
S0 Truss	24,890	11,290	04/08/02
Mobile Base System	3,000	1,361	06/05/02
S1 Truss	31,137	14,124	10/07/02
CETA-A	540	245	10/07/02
P1 Truss	30,871	14,003	11/23/02
CETA-B	540	245	11/23/02
External Stowage Platform 2	5,900	2,676	07/26/05
P3/P4 Truss	34,700	15,740	09/09/06
P5 Truss	4,107	1,863	12/09/06
S3/S4 Truss	35,678	16,183	06/08/07
S5 Truss	4,040	1,833	08/08/07
External Stowage Platform 3	6,937	2,902	08/08/07
Node 2 "Harmony"	31,500	14,300	10/23/07
Columbus Science Laboratory	29,458	13,362	02/11/08
Kibo ELM-PS	18,490	8,387	03/11/08
Kibo JEM-PM	32,628	14,800	05/31/08
S6 Truss	30,937	14,033	03/15/09
Kibo EF	8,200	3,719	07/15/09
Kibo ELM-ES	2,400	1,089	07/15/09
Mini-Research Module 2	8,201	3,720	11/10/09
ExPRESS Logistics Carriers (2, ea)	3,500	1,588	11/16/09
Node 3 "Tranquility"	33,325	15,116	02/08/10
Cupola	4,145	1,880	02/08/10
Mini-Research Module 1	17,712	8,034	05/14/10

Current Total: 170.6 ft long (pressurized); 356.51 ft wide (solar arrays); 48.9 ft high (fixed structure); 816,349 lb; ISS is 98% complete by pressurized volume

ISS Elements to Be Added

Alpha Magnetic Spectrometer	14,870 lb (6,745 kg)
ExPRESS Logistics Carrier 3	13,500 lb (6,123 kg)
ExPRESS Logistics Carrier 4	7,825 lb (3,549 kg)
Pressurized Multipurpose Module	23,555 lb (10,684 kg)
Multipurpose Laboratory Module	46,152 lb (20,934 kg)

ISS Elements on Orbit

Zarya Module

The Zarya module—also known by the technical term Functional Cargo Block and the Russian acronym FGB—was the first component launched for the International Space Station. The U.S.-funded and Russian-built Zarya, which means “sunrise” when translated into English, is a U.S. component of the station, although it was built and launched by Russia. The module was built by the Khru-nichev State Research and Production Space Center, which is also known as KhSC, in Moscow under a sub-contract to The Boeing Company for NASA.

After launch, a set of preprogrammed commands automatically activated the module’s systems and deployed the solar arrays and communications antennas. Only weeks after Zarya reached orbit, space shuttle Endeavour made a rendezvous and attached a U.S.-built connecting module called Node 1, or Unity. The subsequently launched Zvezda service module, a Russian-provided crew living quarters and early station core, enhanced or replaced many functions of Zarya. The Zarya module is now used primarily for its storage capacity and external fuel tanks.



Launched atop a Russian Proton rocket from the Baikonur Cosmodrome, Kazakhstan, launch site, Zarya provides battery power, fuel storage, and rendezvous and docking capability for Soyuz and Progress space vehicles.

Zarya’s side docking ports accommodate Russian Soyuz piloted spacecraft and unpiloted Progress resupply spacecraft. The module’s 16 fuel tanks combined can hold more than six tons of propellant. The attitude

control system for the module includes 24 large steering jets and 12 small steering jets. Two large engines were available for reboosting the spacecraft and making major orbital changes before Zvezda arrived.

Length:	41.2 ft (12.6 m)
Width:	13.5 ft (4.1 m)
Weight:	50,419 lb (22,870 kg)

Node 1 "Unity"

Node 1, the first U.S.-built component of the ISS, is a cylinder-shaped connecting module with six passage-ways, or nodes, to which modules were attached as the station expanded.



ISS Node 1, "Unity" module, and two pressurized mating adapters (PMAs) during space shuttle mission STS-88/ISS-2A

Length:	18 ft (5.49 m)
Width:	15 ft (4.57 m)
Weight:	24,711 lb (11,209 kg)

Zvezda Service Module

The service module was the first fully Russian contribution to the ISS and served as the early cornerstone for the first human habitation of the station.

The module provided the early station living quarters, life support system, electrical power distribution, data processing system, flight control system, and propulsion system. It also provided a communications system that included remote command capabilities from ground flight controllers. Although many of these systems were supplemented or replaced by U.S. station components, the service module will always remain the structural and functional center of the Russian segment of the ISS.

Length:	43 ft (13.1 m)
Width (wingspan):	97.5 ft (29.7 m)
Weight:	53,267 lb (24,162 kg)

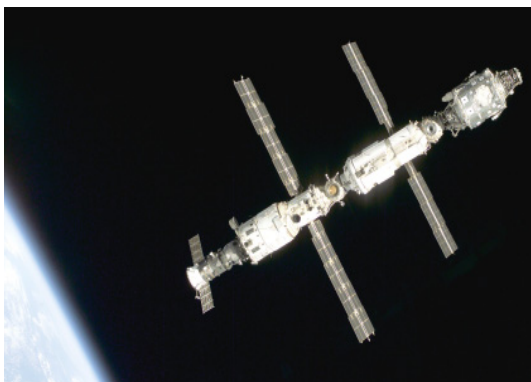

Launched atop a Russian Proton rocket from Baikonur Cosmodrome, Zvezda joined the ISS, docked with Zarya and a Progress supply vehicle.

Node 2 "Harmony"

Harmony, also known as Node 2, was the first pressurized module added to the station since the Russian Pirs Docking Compartment was installed in September 2001. Harmony is a utility hub, providing air, electrical power, water, and other systems essential to support life on the station. It distributes resources from the station's truss to the Destiny lab and to the European Space Agency's Columbus Science Laboratory and the Japanese Experiment Module (Kibo). The module acts as an internal connecting port and passageway to additional international science labs and cargo spacecraft.

In addition to increasing the living and working space inside the station by more than 2,500 cubic feet, its exterior serves as a work platform for the station's robotic arm, Canadarm2. Harmony is similar in shape to the six-sided Unity module, known also as Node 1. Unity links the Destiny lab and the Russian Zarya Module.

Length:	23.6 ft (7.2 m)
Width:	14.5 ft (4.4 m)
Weight:	31,500 lb (14,300 kg)

Node 2 received its name after an academic competition involving students from 32 states. Six different schools submitted "Harmony." A panel of NASA educators, engineers, scientists, and senior agency managers selected the name because it symbolizes the spirit of international cooperation embodied by the station, as well as the module's specific role in connecting the international partner modules.

Harmony was designed and built for NASA by Thales Alenia Space in Torino, Italy, as part of an agreement between NASA and the ESA. The Boeing Company provided a large number of Harmony's subsystem components, including

lights, fans, power switches and converters, racks, air diffusers, smoke detectors, hatches, and passive common berthing mechanisms.

Boeing also built, installed onto Harmony, and tested five active common berthing mechanisms (ACBMs). The mechanisms enable on-orbit mating and airtight seals between ISS pressurized elements. The ACBMs consist of powered, computer-controlled components that align capture and are secured to passive CBMs.

While the ACBM contains all of the powered components and associated alignment hardware for berthing, the passive CBM configurations include the reciprocal mating fittings and alignment components. In a precisely controlled sequence of events, the ISS remote manipulation system positions the mating module passive CBM near the ISS ACBM for automated berthing, resulting in a structurally sealed assembly.

Harmony's installation was a two-step process. First, STS-120/Discovery docked to pressurized mating adapter 2 (PMA-2), located on the end of Destiny. Then the crew attached the new module to a temporary position on the outside of Unity.



In the grasp of the station's Canadarm2, Harmony is moved from its stowage position in the cargo bay of space shuttle Discovery to its temporary location on the ISS.

After Discovery left, the Expedition 16 crew used Canadarm2 to move PMA-2 to the forward port, onto one of the five ACBMs on Harmony. Then, the crew used the arm to move and install Harmony at its permanent location at the end of Destiny.

Node 3 “Tranquility”

The European-built Node 3, the last of the three ISS nodes, was built in Italy by Thales Alenia Space Italia (TASI) as part of the collaboration between the European Space Agency and NASA. Two of the nodes, Node 2 “Harmony” and Node 3, were made under a contract in Europe, while Node 1 “Unity” was made under a NASA contract in the United States. Node 1 has been in orbit since December 1998, while Node 2 has been in orbit since October 2007. Node 3, named in honor of NASA’s historic Apollo 11 moon base, was attached robotically on the port side of Node 1 in February 2010.

Nodes 2 and 3 are an evolution of Node 1. Thales Alenia Space designed Nodes 2 and 3, deriving from the experience with the Multi-purpose Logistics Modules that took into account new habitability requirements, making possible permanent crew quarters for four astronauts, with the capability to treat and recycle water, cater for personal hygiene and waste, jettison carbon dioxide, and generate oxygen.

These nodes are the interconnecting elements between the various pressurized modules on the space station. They provide a shirt-sleeve environment to allow the passage of crew members and equipment through to other station elements and provide vital functions and resources for the crew members and equipment.

Node 3 consists of a pressurized cylindrical hull with a shallow conical section enclosing each end. The pressurized shell is constructed from aluminium alloys and is covered with a multilayer insulation blanket for thermal stability and sections of panelling to act as a protective shield against space debris. This panelling is also constructed of an aluminium alloy, together with a layer of Kevlar and Nextel.

Length:	24 ft (7.3 m)
Width:	14.5 ft (4.4 m)
Weight:	33,325 lb (15,116 kg)

Internal and external secondary structures are used to support the installation of equipment, piping, and electrical harnesses. Low-temperature and moderate-temperature water loops allow the rejection of the heat generated inside the element to the station ammonia lines by means of two heat exchangers mounted on the external side of one end cone.

Boeing produced many of the module’s components, including hatches, berthing mechanisms, ammonia hoses, and ventilation and thermal-coolant valves, at the company’s Huntsville, Ala., facility. The Boeing team also provided engineering and testing support while TASI assembled and tested the module in Torino, Italy.

Node 3 can be considered in two halves. One half has a single docking port on one of the end cones where Node 3 is docked to the station. This half also accommodates eight standard-sized racks, which house relevant systems and equipment. The other half consists of an additional five docking ports, one on the other end cone and four arranged around the circumference of the cylindrical main body of Node 3.

In its launch configuration in the shuttle's cargo bay, Node 3 had the Cupola attached to the end cone that is now connected to PMA-3. In its final in-orbit configuration, the Cupola was relocated to the Earth-facing port of Node 3 during the STS-130 mission.

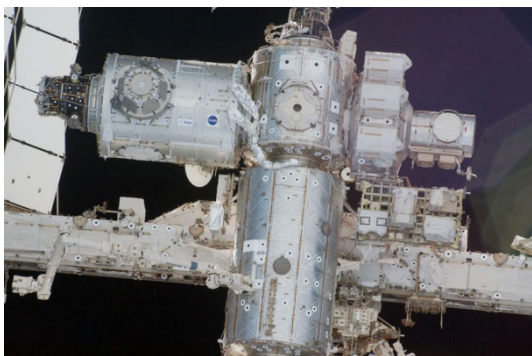

The newly installed Node 3 with its Cupola are seen at top left in this photo taken by an STS-130 crew member as Endeavour and the ISS began their undocking.

Inside Node 3, the eight rack locations are taken up with two avionics racks and six racks containing pallets with equipment and cargo for the station. These include the second Air Revitalization System rack for air composition monitoring including carbon dioxide removal; an Oxygen Generation System rack for producing oxygen from water; Water Recovery System Racks 1 and 2 for urine and water processing; a Waste and Hygiene Compartment Rack for crew waste and hygiene processing, and the COLBERT treadmill. Node 3 also was outfitted with the Advanced Resistive Exercise Device for crew in-orbit physical exercise.

The Cupola

The Cupola is a dome-shaped module with windows through which operations on the outside of the station can be observed and guided. It is a pressurized observation and work area that accommodates command and control workstations and other hardware.

Through the robotics workstation, astronauts are able to control the space station's robotic arm, which helps with the attachment and assembly of station elements.

Spacewalking activities can be observed from the Cupola, along with visiting spacecraft and external areas of the station, with the Cupola offering a viewing spectrum of 360 degrees.



One of the first photos taken after installation of the Cupola on STS-130 showed an image spread across its windows of the Sahara Desert 220 miles below.

However, the Cupola operates as more than a workstation. With a clear view of Earth and celestial bodies, the Cupola has scientific applications in the areas of Earth observation and space science, as well as offering psychological benefits for the crew.

The Cupola's dome, which resembles a bay window, is a single forged unit with no welding, giving it superior structural characteristics.

Length:	10 ft (3 m)
Width:	5 ft (1.5 m)
Weight:	4,145 lb (1,880 kg)

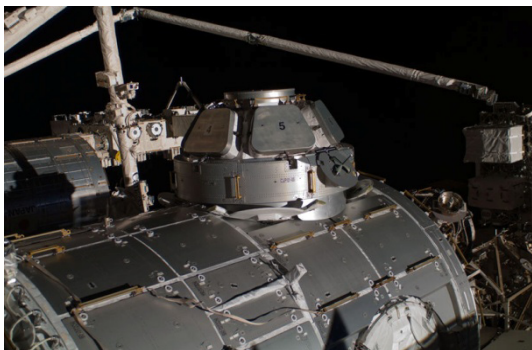

The newly installed Cupola is photographed during EVA 3 of space shuttle mission STS-130.

The Cupola has six trapezoidal side windows and a circular top window of 31.5 inches (80 cm) diameter, making it the largest window ever flown in space. Previously, the largest window on the ISS, a 20-inch (51 cm)-diameter porthole, was in the U.S. Laboratory. Each Cupola window was built using advanced technologies to defend the sensitive fused silica glass panes from exposure to solar radiation and debris impacts.

Each window has three subsections: an inner scratch pane to protect the pressure panes from accidental damage from inside the Cupola; two 0.98-inch (25 mm)-thick pressure panes to help maintain the cabin pressure and environment (the outer pane is a back-up for the inner pane); and a debris pane on the outside to protect the pressure panes from space debris when the Cupola shutters are open.

The windows are protected by special external shutters, which can be opened by the crew inside the Cupola with a simple turn of a wrist. At the end of their tasks, the window shutters are closed to protect the glass from micrometeoroids and orbital debris and to prevent solar radiation from heating up the Cupola or to avoid losing heat to space.

The Cupola's 10-year in-orbit lifetime calls for user-friendly replacement of the windows while in orbit. The entire window or the individual scratch and debris panes can be replaced in space. To replace an entire window, an astronaut would first fit an external pressure cover over the window during a spacewalk. The windows in the Cupola were provided by the Boeing team in Huntsville, Ala.

U.S. Laboratory “Destiny”

Length:	28 ft (8.5 m)
Width:	14 ft (4.3 m)
Weight:	53,602 lb (24,313 kg)
Volume:	3,750 ft ³ (106 m ³)
Windows:	1 - 20 in. (50.9 cm)
No. of Racks:	24 (13 scientific and 11 system)
Exterior:	Aluminum “waffle” pattern, covered with an insulation blanket and intermediate debris shield

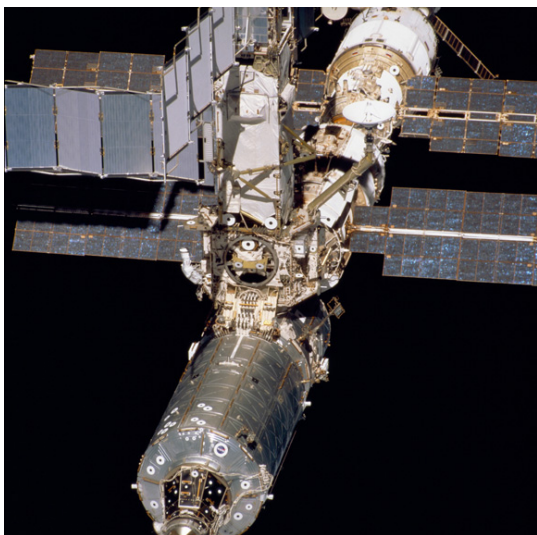

The Destiny Laboratory after its delivery and installation by the STS-98/ISS-5A crew, as seen from the departing space shuttle Atlantis

Considered the centerpiece of the International Space Station, “Destiny,” the U.S. Laboratory module, is a world-class, state-of-the-art research facility in a microgravity environment. Destiny provides astronauts a year-round, shirt-sleeve atmosphere for research in many areas, including life science, microgravity science, Earth science, and space science research. The facilities inside the lab are designed to yield a steady stream of findings from hundreds of high-quality science and technology experiments. It is the primary workstation for the U.S. involvement on the ISS.

Destiny comprises three cylindrical sections and two end-cones. Each end-cone contains a hatch opening through which the astronauts enter and exit the lab.

Made of aluminum, the exterior of the laboratory module has a "waffle" pattern that strengthens the hull. It is covered with an insulation blanket to protect the module from the harsh temperatures of outer space.

An intermediate debris shield made of material similar to that of bulletproof vests protects the module against space debris and micrometeoroids.

An aluminum debris shield was placed over the intermediate debris shield for added protection and to reflect the intense sunlight to reduce the load on the air conditioning system.

Inside, four "stand-off" structures provide space for power lines, data management systems, vacuum systems, air conditioning ducts, water lines, and more, all supporting the space station's racks.

There are 24 racks inside the laboratory, six on each side. Thirteen are scientific racks dedicated to various science experiments, and 11 racks provide power, cooling water, temperature and humidity control, as well as air revitalization to remove carbon dioxide and replenish oxygen. Destiny has a 20-inch (50.9-centimeter) optically pure, telescope-quality glass window located in an open rack bay used primarily for Earth science observations. Station crew members use very high-quality video and still cameras at the window to record Earth's changing landscapes. A window shutter protects the window from potential micrometeoroid and orbital debris strikes during the life of the ISS. The crew manually opens the shutter to use the window.

Each rack is 73-inches (1.9-meters) tall and 42-inches (1.1-meters) wide, basically the size of the average household closet. Made with a graphite composite shell, racks inside the ISS lab weigh around 1,200 pounds (544 kilograms) each.

Boeing began construction of the 16-ton (14.5-tonne) state-of-the-art research laboratory in 1995 at Marshall Space Flight Center in Huntsville, Alabama. Destiny was shipped to Kennedy Space Center in Florida in 1998 and was turned over to NASA for prelaunch preparations in August 2000. It launched on Feb. 7, 2001, aboard the space shuttle Atlantis on STS-98.

U.S. Laboratory "Destiny" Configuration

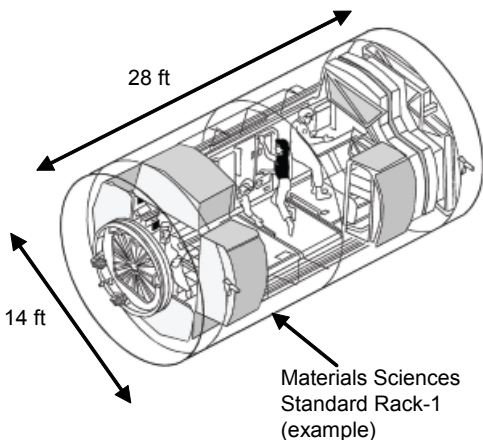

Rack Facts

Height:	73 in. (1.9 m)
Width:	42 in. (1.1 m)
Weight:	1,200 lb (544 kg)
Exterior:	Graphite composite shell

Columbus Laboratory

The Columbus Laboratory is the cornerstone of the European Space Agency's contribution to the ISS and is the first European laboratory dedicated to long-term research in space. Named after the famous explorer from Genoa, the Columbus Laboratory gives an enormous boost to current European experiment facilities in weightlessness and to the research capabilities of the ISS. It has internal and external accommodations for numerous experiments in life sciences, fluid physics, and a host of other disciplines.



The Columbus Laboratory is photographed by an STS-122 crew member on space shuttle Atlantis shortly after the undocking of the two spacecraft.

The Columbus Laboratory consists of a pressurized cylindrical hull closed with welded end cones. To reduce costs and maintain high reliability, the laboratory shares its basic structure and life support systems with the European-built MPLMs.

The primary and internal secondary structures of Columbus are constructed from aluminum alloys. These layers are covered with a multilayer insulation blanket for thermal stability and a further two tons of paneling constructed of an aluminium alloy together with a layer of Kevlar and Nextel to act as protection from space debris.

The Columbus Laboratory has an internal volume of 2,646 cubic feet (75 cubic meters), which can accommodate 16 racks arranged around the circumference of the cylindrical section in four sets of four racks. These racks have standard dimensions with standard interfaces, used in all non-Russian modules, and can hold experimental facilities or subsystems.

Length:	23 ft (7 m)
Width:	15 ft (4.5 m)
Weight:	29,458 lb (13,362 kg)

Ten of the 16 are International Standard Payload Racks (ISPRs) fully outfitted with resources (such as power, cooling, and video and data lines) to be able to accommodate an experiment facility with a mass of up to 1,543 lb (700 kg). The extensive experiment capability of the Columbus Laboratory has been achieved through careful optimization of the system configuration, making use of the end cones for housing subsystem equipment. The central area of the starboard cone carries system equipment such as video monitors and cameras, switching panels, audio terminals, and fire extinguishers.

Although it is the station's smallest laboratory module, the Columbus Laboratory offers the same payload volume, power, and data retrieval as the station's other laboratories. A significant benefit of this cost-saving design is that Columbus was launched already outfitted with 5,511 lb (2,500 kg) of experiment facilities and additional hardware.

Japanese Experiment Module (Kibo)

The first component of the Japanese Experiment Module (JEM), or Kibo, flew to the ISS after 23 years of development efforts by the Japan Aerospace Exploration Agency (JAXA). The Kibo facilities are used to perform collaborative experiments by all the station partners.

Kibo means “hope” and is Japan’s first human-rated space facility. Kibo is the largest experiment module on the space station, accommodating 31 racks in its pressurized section, including experiment, stowage, and system racks. Kibo is also equipped with external facilities that can accommodate 10 exposed experiment payloads.

Kibo is a complex facility that enables several kinds of specialized functions. In total, Kibo consists of six components: two research facilities—the Pressurized Module (PM) and Exposed Facility (EF), a Logistics Module attached to each of them, a Remote Manipulator System—the Japanese Experiment Module Remote Manipulator System (JEMRMS), and an Inter-Orbit Communication System. Kibo also has a scientific airlock through which experiments can be transferred and exposed to the external environment of space.

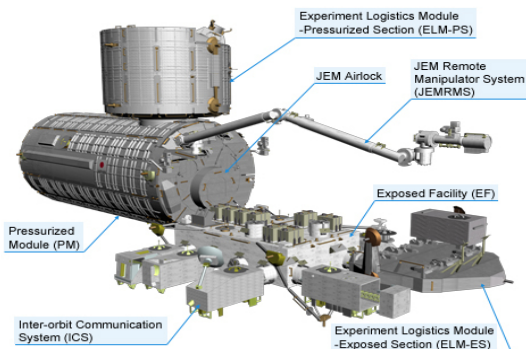

The Kibo elements were delivered to the space station over the course of three space shuttle missions. STS-123 delivered the Experiment Logistics Module–Pressurized Section (ELM-PS) in March 2008, STS-124 delivered the PM and JEMRMS in June 2008, and STS-127 delivered the EF and the Experiment Logistics Module–Exposed Section (ELM-ES) in July 2009. For each of the missions, a JAXA astronaut flew to the station to assist with the assembly, activation, and checkout of the Kibo component.

The ELM-PS is a Kibo storage facility that provides stowage space for experiment payloads, samples, and spare items. The ELM-PS measures 14.4 feet (4.4 meters) wide and 13.8 feet (4.2 meters) long. Up to eight racks can be housed in the ELM-PS. The pressurized interior of the ELM-PS is maintained at one atmosphere, thus providing a room-temperature working environment. The crew can freely move between the ELM-PS and the main experiment module, the Pressurized Module (PM).

During STS-123, the ELM-PS was attached to the zenith port on top of Harmony, the Node 2 module. The ELM-PS remained attached to the Harmony module until the PM was delivered on space shuttle mission STS-124. The final location of the ELM-PS is on the top port of the PM.

The Pressurized Module—the central part of Kibo—and Japanese Experiment Module Remote Manipulator System (JEMRMS) was launched on the STS-124/1J mission. At 36.7 feet (11.2 meters) long and 14.4 feet (4.4 meters) wide, the PM is the station's largest science laboratory. The pressurized interior of the PM is maintained at one atmosphere to provide a room-temperature working environment. The ISS crew conducts unique microgravity experiments within the PM laboratory. The PM holds 23 racks, 10 of which are International Standard Payload Racks designed for experiment payloads.

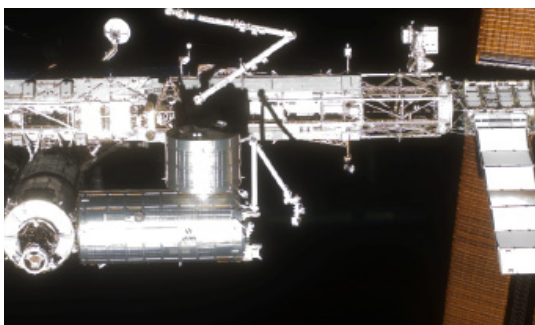

Seen from space shuttle Discovery, mission STS-124, the newly installed Kibo JEM-PM is attached to the port side of the Harmony node. The Kibo ELM-PS and JEMRMS are visible at center.

Kibo's robotic arm, or JEMRMS, serves as an extension of the human hand and arm in manipulating experiments on the EF and enables operation of exposed experiments without the assistance of a spacewalking crew. The JEMRMS is composed of the Main Arm and the Small Fine Arm, both of which have six articulating joints. The Main Arm is used for exchanging EF payloads and for moving large items. The Small Fine Arm, which attaches to the end of the Main Arm, is used for more delicate tasks. The crew operates these robotic arms from the JEMRMS Console located in the PM.

The Exposed Facility (EF) and Experiment Logistics Module–Exposed Section (ELM–ES) was launched on the STS-127/2J/A mission. The EF provides a multipurpose platform where 10 science experiment and system payloads can be deployed and operated in the unpressurized environment of space. The EF measures 18.4 feet (5.6 meters) wide, 16.4 feet (5 meters) high, and 13.1 feet (4 meters) long. The experiment payloads attached to the EF are exchanged using the JEMRMS. The ELM-ES is a pallet that can hold

three experiment payloads, measures 16.1 feet (4.9 meters) wide, 7.2 feet (2.2 meters) high, and 13.8 feet (4.2 meters) long, and is attached to the end of the EF.



A close-up view of the Japanese Experiment Module–Exposed Facility and Kibo laboratory of the ISS photographed by an STS-127 crew member while space shuttle Endeavour was docked with the space station

Mini-Research Module 1

Mini-Research Module 1 (MRM1)—named “Rassvet,” Russian for “Dawn”—is a new Russian module that was delivered to the ISS by space shuttle Atlantis on the STS-132 mission. The module was berthed to the Earth-facing port of the Zarya module using the station’s robotic arm.

On its flight to the station, MRM1 carried 6,482 lb (2,940 kg) of cargo on its internal and exterior stowage locations, including a spare elbow joint for the European Robotic Arm (ERA) and outfitting equipment for the Multipurpose Laboratory Module (MLM)—scheduled to launch on a Russian rocket in 2012—that included a radiator, an airlock for payloads, and a Portable Work Post (PWP) that will provide a spacewalk worksite for ERA activation, checkout, and operations.



In the grasp of Canadarm2, MRM1 is transferred from Atlantis’s payload bay to be attached to Zarya on the ISS.

Developed at RSC Energia, MRM1 also provides a fourth docking port on the Russian operation segment of the station for the docking of Soyuz and Progress vehicles.

Length:	19 ft, 7 in (6 m)
Diameter:	7 ft, 7 in (2.35 m)
Weight:	11,188 lb (5,075 kg)
Habitable volume:	207 ft ³ (5.86 m ³)
Pressurized volume:	614 ft ³ (17.4 m ³)

Mini-Research Module 2

Mini-Research Module 2 (MRM2)—named "Poisk," Russian for "Search"—is a Russian module that arrived at the ISS early in the Expedition 21 increment. It was launched on Nov. 10, 2009, from the Baikonur Cosmodrome, Kazakhstan, on a Russian Soyuz rocket and docked to the space-facing port of the Zvezda service module.

Developed at RSC Energia, MRM2 doubles as an additional airlock for EVAs and as a docking port for Russian vehicles arriving at the space station. The module increases the number of ports on the Russian segment of the station and enables the subsequent addition of another larger module to the Russian segment. MRM2 also provides a docking target for visual monitoring of automated Soyuz and Progress vehicle dockings and offers pressurized volume for stowing cargo and scientific hardware.

On its flight to the station, MRM2 carried 1,764 lb (800 kg) of cargo in its pressurized compartment consisting of Russian Orlan spacesuits and life support equipment.

Length:	13 ft, 3 in (4.049 m)
Diameter:	8 ft, 4 in (2.55 m)
Weight:	8,201 lb (3,720 kg)
Habitable volume:	380 ft ³ (10.7 m ³)
Pressurized volume:	523 ft ³ (14.8 m ³)

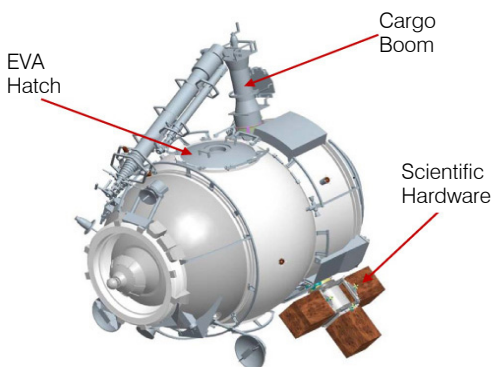

Mini-Research Module 2 External Features

Pressurized Mating Adapters (PMAs)

Conical docking adapters, called pressurized mating adapters (PMAs), allow the docking systems used by the space shuttle and by Russian modules to attach to the ISS. The ISS uses three PMAs to interconnect spacecraft and modules with different docking mechanisms. The first two PMAs were launched with the Unity module in 1998 aboard STS-88. The third was launched in 2000 aboard STS-92.

PMA-1 was one of the first components of the ISS. On STS-88, the crew used the shuttle's robotic arm to attach the Zarya control module to PMA-1, which was already connected to the aft berthing port of Unity. PMA-1 now permanently connects these first two station components. PMA-2 is currently mounted on the forward port of the Harmony connecting node and is used when space shuttle orbiters dock at the station. PMA-3 is located on the outer port on Tranquility.

Airtight seals are formed by devices that pull together, lock, and seal—a different method than the “bump-to-trip latch, then seal” procedure that most spacecraft use to dock. The tight seal that permits shirt-sleeved transit between ISS elements and spacecraft is provided in part by common berthing mechanism technology. PMAs are Boeing products, built in Huntington Beach, Calif.

Length:	7 ft (2.13 m)
Diameter:	5 ft (1.5 m) at one end, 9 ft (2.74 m) at the other
Material:	Aluminum pressure shell with an aluminum debris shield

Joint Airlock “Quest”

The Joint Airlock module, which has the capability to be used by both Russian and U.S. spacesuit designs, consists of two sections, a crew lock that is used to exit the station and begin a spacewalk, and an equipment lock used for storing gear.

Length:	18 ft (5.5 m)
Diameter:	13 ft (4 m)
Weight:	20,831 lb (9,449 kg)
Volume:	1,200 ft ³ (34 m ³)
Material:	Aluminum, covered with insulation blankets and intermediate debris shields
Number of racks:	Two systems racks
Delivered:	Space shuttle mission STS-104/ISS-7A

Joint Airlock “Quest” Configuration

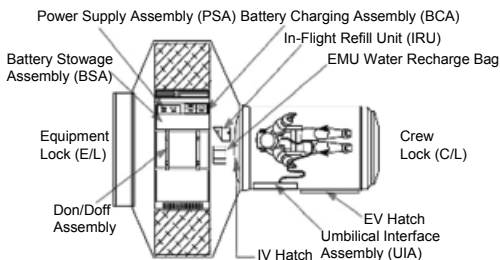

Pirs Docking Compartment

The Pirs docking compartment is attached to the bottom, Earth-facing port of the Zvezda service module. It was launched on a Russian Soyuz rocket on Sept. 14, 2001, and configured during three spacewalks by the Expedition 3 crew.

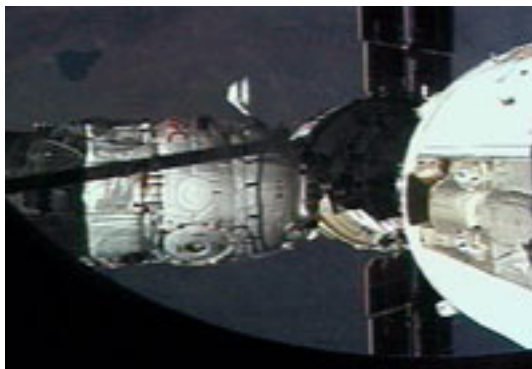

Video-recorded by one of the Expedition 3 crew members, Pirs docks with the ISS on Sept. 16, 2001.

Pirs, Russian for “pier,” has two primary functions. It serves as a docking port for transport and cargo vehicles to the ISS and as an airlock for the performance of spacewalks by two station crew members using Russian Orlan spacesuits.

In addition, the docking compartment can transport fuel from the fuel tanks of a docked Progress resupply vehicle to either the Zvezda or the Zarya. It can also transfer propellant from the Zvezda and Zarya to the propulsion system of docked vehicles—Soyuz and Progress.

Length:	16 ft (4.91 m)
Width:	8.4 ft (2.55 m)
Weight:	7,150 lb (3,243 kg)

Zenith 1 (Z1) Truss

The first truss piece, the Z1 truss, was launched on STS-92 and subsequently permanently attached during space shuttle mission STS-97. Although not a part of the main truss, the Z1 truss was the first permanent lattice-work structure for the ISS, very much like a girder, setting the stage for the future addition of the station's major trusses. It is unpressurized but features two common berthing mechanism docking ports for easy connecting and data communications. Originally used as a temporary mounting position for the P6 truss and solar array, the Z1 solely houses control moment gyroscopes (CMGs) for stabilization and orientation and communications systems. It is also equipped with several spacewalk aids: EVA tool stowage devices (ETSDs), grapple fixture, and handholds and handrails.

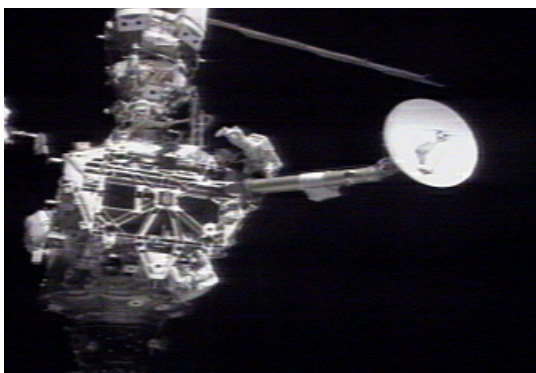

STS-92/ISS-3A astronauts work with the antenna on the newly deployed Z1 truss structure.

Length:	16.1 ft (4.9 m)
Width:	13.8 ft (4.2 m)
Weight:	19,227 lb (8,721 kg)

Starboard 0 (S0) Truss

The central integrated truss (starboard 0) forms the center backbone of the ISS. It is attached to the U.S. Laboratory and is used to route power to the pressurized station modules and conduct heat away from the modules to the S1 and P1 trusses.

The truss segments were numbered in ascending order outward to the port and starboard sides. At one time, an S2 and P2 were planned but were eliminated when the station design was scaled back. From S0, the truss segments are P1, P3, P4, P5, and P6; and S1, S3, S4, S5, and S6.



Central integrated truss (S0) following installation during space shuttle mission STS-110/ISS-8A

Length:	44 ft (13.4 m)
Width:	15 ft (4.6 m)
Weight:	24,890 lb (11,290 kg)

Starboard 1 (S1) Truss

The S1 truss, the first starboard truss segment, was attached to the starboard side of the S0 truss on Oct. 10, 2002. The S1 truss provides structural support for the Active Thermal Control System, Mobile Transporter, and a Crew and Equipment Translation Aid cart. The cart is manually operated by a spacewalker and can also be used as a work platform. The cooling system is like the one in a car radiator except that it uses 99.9 percent pure ammonia, compared to 1 percent in household products. The Thermal Radiator Rotary Joint rotates the three radiator structures that contain eight panels each in a 105-degree span either way to keep the three radiators' panels in the shade; it also transfers power and ammonia to the radiators. In addition, the S1 truss has mounts for cameras and lights, as well as antenna support equipment for S-band communications equipment. Detailed design, test, and construction of the S1 structure were conducted by Boeing in Huntington Beach, Calif.



S1 truss being installed during space shuttle mission STS-112/ISS-9A

Length:	45 ft (13.7 m)
Width:	15 ft (4.6 m)
Weight:	31,137 lb (14,124 kg)

Port 1 (P1) Truss

The P1 truss, the first port truss segment, was attached to the port side of the S0 truss on Nov. 26, 2002. The P1 truss provides structural support for the Active Thermal Control System, Mobile Transporter, and a second Crew and Equipment Translation Aid cart. The cart is manually operated by a spacewalker and can also be used as a work platform. The cooling system is like a car radiator except that it uses 99.9 percent pure ammonia, compared to 1 percent in household products. The Thermal Radiator Rotary Joint rotates the three radiator structures that contain eight panels each in a 105-degree span either way to keep the three radiators' panels in the shade; it also transfers power and ammonia to the radiators. In addition, the P1 truss has mounts for cameras and lights, as well as antenna support equipment for both UHF and S-band communications equipment. The S-band equipment is currently on the P6 truss. Detailed design, test, and construction of the P1 structure were conducted by Boeing in Huntington Beach, Calif.

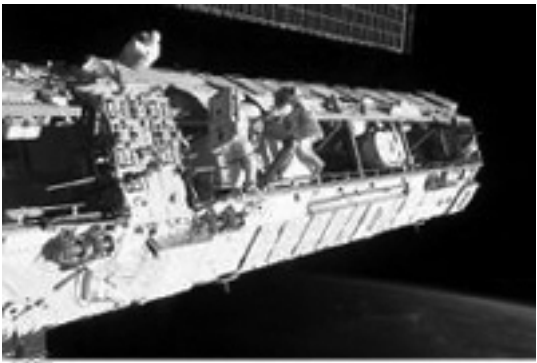

P1 truss being installed during space shuttle mission STS-113/ISS-11A

Length:	45 ft (13.7 m)
Width:	15 ft (4.6 m)
Weight:	30,871 lb (14,003 kg)

Starboard 3 and 4 (S3/S4) Trusses

The starboard 3 and 4 (S3/S4) truss segments were the largest and heaviest space station payload. The principal functions of the S3 and S4 truss segments are to provide electrical power and data interfaces for future mission payloads and convert sunlight to electricity. The segments include another set of solar array wings (SAWs) and a second solar alpha rotary joint (SARJ), which keeps the arrays permanently pointed toward the sun.

Designed by The Boeing Company, the S3/S4 truss segments, which are attached to the S1 truss, were the second starboard addition to the 11-segment integrated truss structure that spans more than 300 feet to carry power, data, and temperature control for the orbital outpost's electronics. Beside two SAWs and a SARJ, the S3/S4 structure has several distinct elements: the integrated equipment assembly (IEA), two beta gimbal assemblies (BGAs), and the photovoltaic thermal control subsystem (PVTCS).

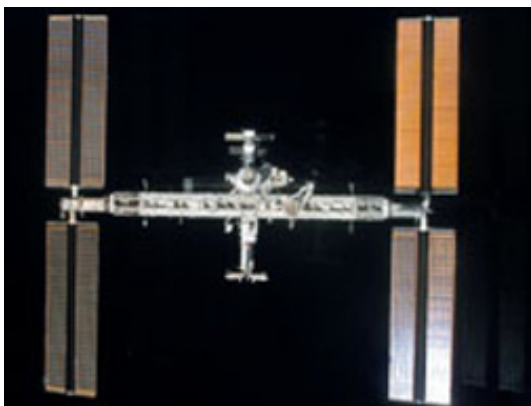

Backdropped by the blackness of space, the ISS is shown in its expanded configuration after the installation of the S3/S4 truss during space shuttle mission STS-117/ISS-13A.

The major S3 subsystems include the SARJ, segment-to-segment attach system (SSAS), and payload attach system (PAS). The S3 truss segment provides mechanical, power, and data interfaces to payloads attached to the four PAS platforms, axial indexing for solar tracking via the SARJ, translation and work site accommodations for the mobile transporter, and accommodations for ammonia servicing of the outboard PV modules and two multiplexer/demultiplexers (MDMs). The MDMs are basically computers that tell other electrical components when to turn on and off and monitor hardware. The S3 also provides a passive attachment point to the S1 segment via the SSAS and pass through of power and data to and from the outboard segments.

Major subsystems of the S4 truss are the port inboard photovoltaic module (PVM), the photovoltaic radiator (PVR), the alpha joint interface structure (AJIS), and the modified Rocketdyne truss attachment system (MRTAS). The S4 PVM includes all equipment outboard of the SARJ outboard bulkhead, namely the two photovoltaic array assemblies (PVAAs) and the IEA. The PVR provides thermal cooling for the IEA. The AJIS provides the structural transition between S3 and S4. Each PVAAs consists of a SAW and BGA. The S4 also contains the passive side of the MRTAS that will provide the structural attachment for the S5 truss.

Length:	44.8 ft (13.7 m)
Width:	16.3 ft (5 m)
Weight:	35,678 lb (16,183 kg)

Port 3 and 4 (P3/P4) Trusses

The port 3 and 4 (P3/P4) trusses are attached to the P1 truss and provide an attachment point for P5. The P3 and P4 trusses also provide a second set of solar array wings (SAWs) and the first alpha joint. Each solar wing, deployed in opposite directions from each other, is 115 feet by 38 feet. The segments support utility routing, power distribution, and a translation path for the mobile base system (MBS). Major P3 subsystems include the segment-to-segment attach system (SSAS), solar alpha rotary joint (SARJ), and unpressurized cargo carrier attach system (UCCAS). Major P4 subsystems include the photovoltaic radiator (PVR), alpha joint interface structure (AJIS), modified Rocketdyne truss attachment system (MRTAS), and integrated equipment assembly (IEA).

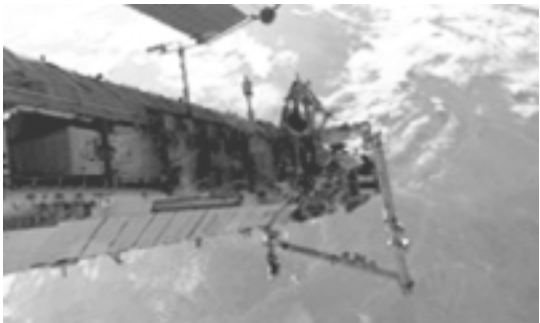

P3/P4 truss being installed during space shuttle mission STS-115/ISS-12A

Length:	44 ft, 10 in. (13.7 m)
Width:	16 ft, 4 in. (5 m)
Weight:	34,700 lb (15,740 kg)

With the P4 element, NASA has deployed the first external wireless instrumentation system (EWIS). The system consists of accelerometers placed around the outboard integrated truss structure. The vibration data seen by the accelerometers will be compared with their loads models so they can be further refined by engineers with actual on-orbit data to better predict the fatigue life and durability of the station's integrated truss structure. This wireless system supplements 33 hard-wired accelerometers installed on the inboard truss elements (S0, S1, S3, P1, and P3).

Starboard 5 (S5) Truss

During STS-118, space shuttle Endeavour delivered the Boeing-built square-shaped starboard 5 (S5) segment to the right side of the ISS. S5 is part of the 11-segment ITS and the third starboard truss element to be delivered. The ITS forms the station's backbone with mountings for unpressurized logistics carriers, radiators, solar arrays, and various other elements. S5 was attached to the S4 truss element via the Modified Rocketdyne Truss Attachment System (MRTAS) interface. S5 is used primarily to connect power, cooling lines, and serves as a spacer between the S4 photovoltaic module (PVM) and S6 PVM, which was joined during a later assembly mission. S5 is very similar in construction to the long spacer located on S6. Without the S5 short spacer, the S4 and S6 solar arrays would not be able to connect because of the way the photovoltaic arrays (PVAs) are deployed on orbit.

The girder-like structure is made of mostly aluminum and provides several extravehicular aids, robotic interfaces, ammonia servicing hardware (as part of the station's External Active Thermal Control System that allows ammonia fluid to transfer from S4 to S6), and can also accommodate an external storage platform. The Enhanced Universal Trunnion Attachment System (EUTAS) allows platforms to be attached to S5 for the storage of additional science payloads or spare orbital replacement units (ORUs). S5 also has white thermal blankets on the structure, which help shade the S4 solar array assembly ORUs.

Length:	11.1 ft (3.4 m)
Width:	14.1 ft (4.3 m)
Weight:	4,010 lb (1,819 kg)

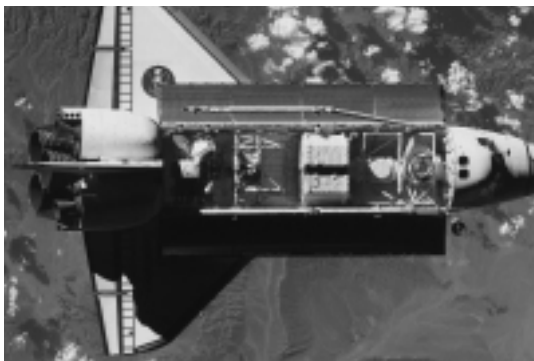

Space shuttle Endeavour approaches the ISS during mission STS-118 with the S5 truss section ready to be installed.

Port 5 (P5) Truss

The square-shaped port 5 (P5) truss segment delivered by STS-116 to the ISS is part of the 11-segment integrated truss structure and the sixth truss element to be delivered. The truss structure forms the backbone of the ISS with mountings for unpressurized logistics carriers, radiators, solar arrays, other hardware and the various elements. P5 was attached to the P4 truss element via the MRTAS interface. P5 is used primarily to connect power and cooling lines and serve as a spacer between the P4 photovoltaic module (PVM) and P6 PVM. P5 is very similar in construction to the long spacer located on P6. Without the P5 short spacer, the P4 and P6 solar arrays would not be able to connect because of the way the photovoltaic arrays are deployed on orbit.

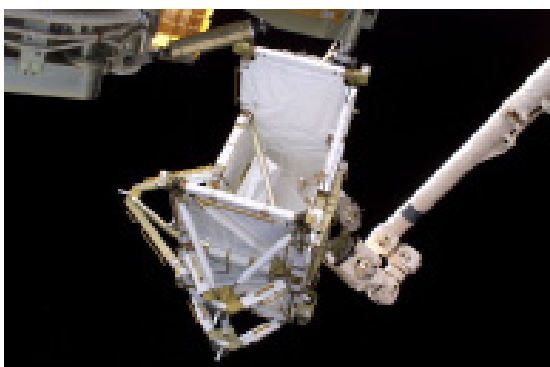

The new P5 truss awaits installation following the hand-off from the shuttle's robotic arm to the station's Canadarm2.

Length:	11 ft, 1 in. (3.37 m)
Width:	14 ft, 11 in. (4.55 m)
Weight:	4,107 lb (1,863 kg)

The girder-like structure is made of mostly aluminum and provides several extravehicular aids, robotic interfaces, ammonia servicing hardware (as part of the station's External Active Thermal Control System that allows ammonia fluid to transfer from P4 to P6) and can also accommodate an external storage platform. The Enhanced Universal Trunnion Attachment System (EUTAS) allows platforms to be attached to P5 for the storage of additional science payloads or spare orbital replacement units. P5 also has white thermal blankets on the structure, which help shade the P4 solar array assembly ORUs.

Another element of P5 is the photovoltaic radiator grapple feature (PVRGF). For launch, the PVRGF was stowed on top of P5 and used by the shuttle and station robotic arms to grab P5 to lift it from the shuttle cargo bay and attach it to the station. After P5 was attached to P4, the PVRGF was relocated to the truss' keel. P5 also contains a remote sensor box, two tri-axial accelerators, and two antenna assemblies as part of the External Wireless Instrumentation System (EWIS). EWIS will give engineers a better understanding of the actual response of the truss system on orbit to vibration and other stresses and help engineers predict the fatigue life and durability of the truss structure.

Boeing's Rocketdyne Power and Propulsion division (now Hamilton Sundstrand) designed P5. The component was constructed in Tulsa, Okla., and arrived at Kennedy Space Center in 2001 for final manufacture, acceptance and checkout. Boeing will continue to provide sustaining engineering of P5 and for the entire integrated truss assembly.

Starboard 6 (S6) Truss

The Boeing-designed starboard 6 (S6), the final truss element delivered by space shuttle Discovery on mission STS-119/ISS-15A, completed the station's 11-segment integrated truss structure (ITS). The 310-foot ITS to which the S6 is attached forms the backbone of the space station, with mountings for unpressurized logistics carriers, radiators, solar arrays, and various elements.



Backdropped by the blackness of space and Earth's horizon, a portion of the Columbus laboratory, starboard truss, and solar array panels are shown after the installation of the S6 truss during space shuttle mission STS-119/ISS-15A.

Major subsystems of the S6 truss are the starboard outboard photovoltaic module (PVM), the photovoltaic radiator (PVR), the long spacer truss (LST), and the modified Rocketdyne truss attachment system (MRTAS).

The PVMs use a large number of solar cells assembled onto solar arrays to produce high power levels. NASA and Lockheed Martin developed a method of mounting the solar arrays on a "blanket" that can be folded like an accordion for delivery to space and then deployed to its full size once in orbit.

The station power system, consisting of U.S. and Russian hardware and four photovoltaic modules, uses between 84–120 kilowatts of power. Some of the electricity is needed to operate space station systems, but the addition of the S6 nearly doubled the amount of power available to perform scientific experiments on the station, from 15 kilowatts to 30 kilowatts.

The two solar array wings (SAWs) on the S6 module were deployed in the opposite direction of the other. Each SAW is made up of two solar blankets mounted to a common mast. The addition of S6 brought the station's total SAWs to eight. Each wing is 115 by 38 feet wide and, with all eight fully deployed, has a total surface area of 38,400 square feet.

Length:	45.4 ft (13.8 m)
Width:	16.3 ft (5 m)
Weight:	34,919 lb (15,839 kg)

The solar arrays produce more power than can be made available to the station's systems and experiments. Because all or part of the solar arrays are eclipsed by the Earth or station structure at times, batteries are used to store electricity for use during those periods.

A unique feature of the S6 is that it carries two spare battery charge/discharge units (BCDUs), used for controlling the charge and discharge of spare batteries on the station. The S6 segment was modified to carry the additional BCDUs, attached to the segment's long spacer truss structure.

The SAWs also are oriented by the beta gimbal assembly (BGA), which can change the pitch of the wings by spinning the solar array. Both the solar alpha rotary joint (SARJ) and BGA are pointing mechanisms and mechanical devices used to point the arrays toward the sun. They can follow an angle target and rotate to that target in the direction toward the sun. Controllers in orbit continuously update those targets so they keep moving as the station orbits the Earth every 90 minutes, maintaining the same orientation toward the sun at the same orbital rate. The SARJ mechanism rotates 360 degrees every orbit, or about 4 degrees per minute, whereas the BGA moves only about four or five degrees per day.

Port 6 (P6) Truss—Solar Array

The U.S.-made photovoltaic solar arrays attached to the port 6 (P6) truss segment use purified silicon solar cells to directly convert light to electricity, which allows the crew to live comfortably, to safely operate the station, and to perform scientific experiments.

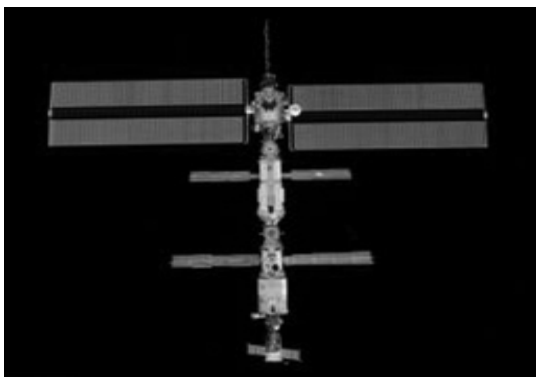

ISS after installation of the P6 truss on space shuttle mission STS-97/ISS-4A

Length:	240 ft (73.2 m)
Width:	35 ft (10.7 m)
Weight:	30,689 lb (13,920 kg)

External Stowage Platforms

The External Stowage Platforms (ESPs) are unpressurized external storage pallets with attachment sites capable of holding ISS spare parts and assemblies. The pallets also have handrails and attachment points for tethers and foot restraints that astronauts can use while working with orbital replacement units (ORUs), which are attached to the ESPs with Flight Releasable Attachment Mechanisms (FRAMs). The ISS robotic arm can be used to move large ORUs stored on the pallet, but astronauts can move smaller parts during a spacewalk. Electrical power for the pallets and their contents is provided by the ISS. Most of the ORUs have heaters to keep their internal components from getting too cold while being stored on an ESP.

ESP-1 was installed during STS-102/ISS-5A.1 and is mounted on the aft portion of Destiny. ESP-1 is the smallest ESP and has two FRAMs to store ORUs. Unity provides power to ESP-1, which in turn makes power available to both ORU storage areas.

ESP-2, installed during STS-114/ISS-LF1, is derived from an Integrated Cargo Carrier (ICC), an equipment carrier designed for use in the payload of the orbiter. ESP-2, the largest of the ESPs with eight FRAMs, was adapted for deployment on the ISS by developing a device to attach it to the ISS Quest airlock. Primary power for ESP-2 comes from Unity, and secondary power comes from the S0 truss.

ESP-3, installed during STS-118/ISS-13A.1, was the first ISS element installed completely by robotics using only the shuttle and station's robotic arms, an External Berthing Camera System (BCS), and a Photovoltaic Radiator Grapple Fixture (PVRGF). ESP-3 has six FRAMs to secure or release the ORUs and other equipment stored on it and Ammonia Tank Assembly (ATA) Flight Support Equipment (FSE) directly mounted to a seventh site. Like ESP-2, the platform is derived from an ICC, and it is attached to the P3 truss, which supplies its primary power.



The space shuttle robotic arm moves away following the hand-off of ESP-3 to the station's robotic arm while docked with the ISS during mission STS-118/ISS-13A.1.

ExPRESS Logistics Carrier

The Expedite the Processing of Experiments to the Space Station (ExPRESS) Logistics Carrier (ELC) is an unpressurized attached payload platform for the ISS that provides mechanical mounting surfaces, electrical power, and command and data handling services for science experiments. ELC was formerly called "ExPRESS Pallet" and is the unpressurized counterpart to the pressurized ExPRESS Rack.

An ELC provides scientists with a platform and infrastructure to deploy experiments in the vacuum of space without requiring a separate dedicated Earth-orbiting satellite. ELCs interface directly with the ISS integrated truss carrier attach system (CAS). The ELC serves as a parking place for spare hardware that can be replaced robotically once on orbit.

Five ELC units are planned, with all having full-up avionics subsystems. Four ELCs will be delivered to the ISS before the scheduled retirement of the space shuttle. Two ELCs will be attached to the starboard truss 3 (S3), and two ELCs will be attached to the port truss 3 (P3). By attaching the ELCs at the S3/P3 sites, a variety of views such as zenith (deep space) or nadir (Earthward) direction with a combination of ram (forward) or wake (aft) pointing allows for many possible viewing opportunities.

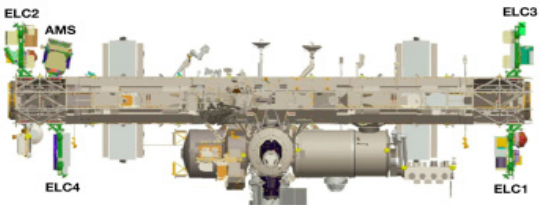

Each ELC can accommodate 12 flight releasable attachment mechanism (FRAM)-based cargos, which include two payload attached sites. The mass capacity for an ELC is 9,800 lb (4,445 kg) with a volume of 98 ft³ (30 m³). The ISS provides power to the ELCs through two 3 kW, 120 Vdc feeds at the ISS-to-ELC interface. The ELC power distribution module converts the 120 Vdc power to 120 Vdc and 28 Vdc. Both power voltages are provided to each payload attached site by separated buses.

Within the electrical subsystem of the ELC, the ExPRESS carrier avionics (ExPCA) provide electrical power distribution to experiments and data interfaces to the ISS. Within the ExPCA, the ColdFire-based flight computer, software, and related electronics comprise its "flight controller unit" (FCU).

STS-129/ISS-ULF3 marked the first flight of ELC1 and ELC2. ELC1 was mounted on the P3 truss element CAS, while ELC2 was placed on the S3 truss upper outboard passive attachment system (PAS). The CAS and PAS were deployed during the STS-128 mission.



Canadarm2 mated ELC2 to the PAS on the ISS S3 truss, controlled by space shuttle and station crews during space shuttle mission STS-129.

Both ELC1 and ELC2 measure approximately 16 feet by 14 feet (5 meters by 4.3 meters without the orbital replacement units installed) and weigh about 3,500 lb (1,588 kg without the ORUs). The weight of ELC1 with ORUs was 13,752 lb (6,238 kg) while ELC2 weighed 13,295 lb (6,031 kg) with ORUs installed.

A total of 14 large ORUs were carried on ELC1 and ELC2. All of the hardware for this mission was processed by Boeing under its Checkout, Assembly and Payload Processing Services (CAPPS) contract with NASA. The ORUs included the ammonia tank assembly (ATA), battery charger discharge unit (BCDU), cargo transportation container (CTC), two control moment gyroscopes (CMGs), high-pressure gas tank (HPGT), Canadarm2 latching end effector (LEE), Materials International Space Station Experiment 7 (MISSE-7), two nitrogen tank assemblies (NTAs), plasma contactor unit (PCU), two pump module assemblies (PMAs), and a trailing umbilical system–reel assembly (TUS-RA).

ELC3 is currently slated for mission STS-134, launching in February 2011. ELC4 is currently slated for mission STS-133, scheduled to launch in November 2010. ELC5 is not manifested and is considered a flight spare. The Alpha Magnetic Spectrometer (AMS) will occupy the spot of ELC5 on the truss.

Engineers from NASA's Goddard Space Flight Center (GSFC) in Greenbelt, Md., developed the lightweight ELC design, which incorporates elements of both the ExPRESS Pallet and the unpressurized logistics carrier. Remmele Engineering, based in Minneapolis, Minn., built the integral aluminum ELC decks for NASA. GSFC, with support from JSC and MSFC, served as the overall integrator and manufacturer for ELC1 and ELC2.

Multipurpose Logistics Modules (MPLMs)

The MPLM was originally designed for Space Station Freedom, the precursor design to the ISS. Initially, it was to be built by Boeing, but in 1992 the Italian Space Agency (ASI) announced that it would build a "Mini-Pressurized Logistics Module" able to carry approximately 9,000 lb of cargo. After a 1993 redesign, the length was doubled, and it was renamed the "Multi-Purpose Logistics Module."

The MPLMs were Italy's contribution to the ISS, and in exchange, the Italian Space Agency was given access to research time on the station. ASI chose the names Leonardo, Raffaello, and Donatello for the modules because they represent some of the great engineers in Italian history: Leonardo da Vinci, Donato di Niccolo di Betto Bardi, and Raffaello Sanzio.

The pressurized, reusable MPLMs function both as ISS "moving van" cargo carriers and as a space station module. Each MPLM is sent to the ISS via the space shuttle. When in the cargo bay, the MPLM is independent of the shuttle cabin, and there is no passageway for crew members to travel from the shuttle cabin to the module. After the shuttle docks with the ISS, the shuttle's robotic arm lifts and transfers the MPLM from the cargo bay to the station. It's then bolted in place to the Node 2 Harmony module nadir port, and power, data, and water cables make it a fully functioning extra work area.



ISS crew member Yuri Gidzenko is surrounded by transient hardware aboard MPLM Leonardo, which was carried to the ISS on space shuttle mission STS-102/ISS-5A.1.

Inside, there are racks of equipment and stowage items that the crew uses for daily living and specific experiments and procedures. When the materials have been used, the MPLM is then loaded with old equipment, racks, and other items no longer needed. The robotic arm returns the MPLM to the shuttle's cargo bay, and it makes the return trip home.



MPLM Raffaello is temporarily attached to Node 2 during its use on space shuttle mission STS-114/ISS-LF1.

The cylindrical modules can carry up to 15,000 lb of cargo, the equivalent of a semi-truck trailer, packed into 16 standard space station equipment racks. ISS racks aren't merely shelves, however. Racks on the ISS and space shuttle are self-contained cabinets that hold entire experiments or other projects. Each rack is a refrigerator-size carbon fiber box, and from there it can be customized to fit its need. Depending on the purpose of any given rack, the MPLM can be equipped with power, data, and fluid to support refrigerators or freezers, or it can be used to stow excess materials. In order to function as an attached ISS module as well as a cargo transport, the MPLM also includes components that provide some life support, fire detection and suppression, electrical distribution, and computer functions.

Length:	21 ft (6.4 m)
Width:	15 ft (4.6 m)
Weight:	9,000 lb (4,082 kg) (empty)

The Leonardo module was launched for the first time on space shuttle mission STS-102/ISS-5A.1. The Raffaello module was launched for the first time on space shuttle mission STS-100/ISS-6A. Donatello is not currently on the shuttle manifest to fly because of the cost associated with getting the module up to flight status code. NASA has modified the Leonardo MPLM and will leave it permanently attached to the Unity module on space shuttle mission STS-133. Modifications included installing blankets in between the walls of the MPLM to protect against micrometeoroid and orbital debris strikes,

changing power outlets, and altering Leonardo's heating and cooling systems. Redesignated as the Pressurized Multipurpose Module (PMM), the module will primarily be used for storage of spares, supplies, and waste on the ISS.

The Mobile Servicing System

Canada has contributed an element essential to the construction, operations, and maintenance of the ISS: the Mobile Servicing System (MSS). The MSS is composed of the Space Station Remote Manipulator System (SSRMS), the Mobile Base System (MBS), and the Special Purpose Dexterous Manipulator (SPDM). These three components have been designed to work together or independently.

The MSS, better known by its primary component Canadarm2 (the SSRMS), is a robotic system that operates both autonomously or under astronaut control. It plays a key role in station assembly and maintenance: moving equipment and supplies around the station, supporting astronauts working in space, and servicing instruments and other payloads attached to the space station.

Launched on STS-100, the next-generation Canadarm2 is a bigger, more versatile version of the space shuttle's robotic arm. Canadarm2 is capable of handling large payloads of up to 256,000 lb (116,000 kg).

Length: 57.7 ft (17.6 m)

Width: 13.8 in. (35 cm)

Weight: 3,618 lb (1,800 kg)

It has seven motorized joints and can move end-over-end in an inchworm-like movement to reach many parts of the space station, locking its free end on one of many special fixtures called Power and Data Grapple Fixtures (PDGFs) and then detaching its other end and pivoting it forward. In this movement, it is limited only by the number of PDGFs on the station. PDGFs placed strategically around the station provide power, data, and video to the arm through its latching end effectors (LEEs). Its speed when unloaded is 1.21 foot per second and when loaded (for station assembly) is 0.79 inch per second.



STS-114/ISS-LF1 mission specialist Stephen K. Robinson, anchored to a foot restraint on Canadarm2, participates in an EVA.

The Mobile Base System (MBS), a moveable work platform added to the station during STS-111, and the U.S.-provided Mobile Transporter (MT), installed during STS-110, glide down rails on the station's trusses, putting much of the station within grasp of the arm. When Canadarm2 is attached to the MBS, it has the ability to travel to work sites all along the truss structure. Astronauts also use the MBS as a platform from which to perform spacewalks as well as a storage facility where they can keep various tools.



The MBS is moved by Canadarm2 for installation on the ISS during space shuttle mission STS-111/ISS-UF2.

Since the MBS has four PDGFs, it can serve as a base for both Canadarm2 and the SPDM simultaneously. Through these anchor points, the MBS provides power and data to the robotics as well as to the payloads that they may be supporting.

Length: 18.7 ft (5.7 m)

Width: 14.8 ft (4.5 m)

Weight: 3,197 lb (1,450 kg)

The high-strength aluminum and titanium MT—the first railroad in space—has a payload capacity of 46,100 lb (20,911 kg). Its top speed is about 1 inch per second. The MT is prevented from separating from the ISS in the microgravity environment of space by using wheels that are both under and above the tracks, similar to a suspension roller coaster at an amusement park. The MT is controlled by complex software that dictates its movements. When the MT stops at work sites along the line, it can be locked down with a 7,000-lb grip to hold it in place so Canadarm2 can safely maneuver cargo. Although it can be driven from on board the station, the flight controllers in the Mission Control Center in Houston often drive the train from thousands of miles away and hundreds of miles below.

Length: 9 ft (2.7 m)

Width: 8.6 ft (2.6 m)

Weight: 1,950 lb (885 kg)

The Special Purpose Dexterous Manipulator, also known as Dextre or the Canada hand, is a highly advanced two-armed robot. It can work solo, fixed to one of the PDGFs on the station, or on the MBS. Most of the time, Dextre will do its work while attached to the free end of Canadarm2, which will maneuver Dextre into position next to the payload that requires maintenance. Dextre can be operated by crew members inside the ISS or by flight controllers on the ground.



Dextre in the grasp of Canadarm2

Dextre resembles a headless torso fitted with two extremely agile arms and several smaller appendages. The two arms each have seven specially offset joints that give tremendous freedom of movement. At the end of each of the arms is the Orbital Replacement Unit/Tool Changeout Mechanism (OTCM), which provides built-in grasping jaws, a retractable socket drive, a monochrome TV camera, lights, and umbilical connectors. The lower torso has a pair of color TV cameras, an ORU platform, and tool holders. The torso pivots at the waist to perform sophisticated operations, including installing and removing small payloads such as batteries, supplies, and computers. It can also handle tools such as specialized wrenches and socket extensions for delicate maintenance and servicing tasks.

Length:	11.5 ft (3.5 m)
Width:	7.7 ft (2.3 m)
Weight:	3,664 lb (1,662 kg)

Crew and Equipment Translation Aid

Spacewalking crew members needed a work platform that could provide them with a means of transporting themselves, tools, and orbital replacement units (ORUs) safely and easily along the ISS truss structure. The Lockheed Martin-built Crew and Equipment Translation Aid (CETA)—one of the largest pieces of EVA equipment built for the ISS—is NASA's equivalent of a flatbed truck.

Length:	8.25 ft (2.5 m)
Width:	7.75 ft (2.4 m)
Weight:	623 lb (283 kg)

Two CETAs were launched in 2002 as integrated parts of the S1 and P1 truss segments. The first CETA was launched on STS-112, station assembly flight 9A. The second CETA was launched on STS-113, station assembly flight 11A.

Crew members can propel themselves and accompanying hardware manually along the Mobile Transporter (MT) rails, which run the length of the truss structure. The two CETA carts are located one on each side of the MT for usage flexibility. If required, a cart may be moved to the other side of the MT to complement the other cart. A CETA cart can be used alone or coupled to the MT. When not in use, the CETAs attach to the MT for stowage.

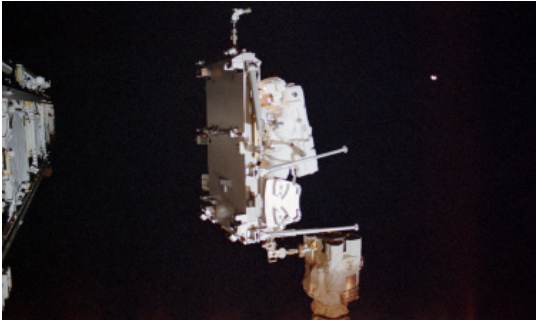

Mission specialist John Herrington, anchored on Canadarm2, moves the CETA during an STS-113/ISS-11A EVA.

The CETAs have attachment points for other EVA hardware such as the ORU Transfer Device (OTD), also known as the Space Crane; Articulating Portable Foot Restraint (APFR); EVA Tool Stowage Device (ETSD); and a host of other small crew and equipment restraining tools. During ISS assembly operations, crew members also use CETA as a work platform to reach 90 percent of the work sites safely.

CETA is made of many components, including the following major subassemblies:

- A 142-lb (64 kg) main frame
- A 126-lb (57 kg) toolbox to stow EVA tools
- Launch restraints to ensure CETA is secured to the truss segment
- A wheel/brake subsystem to move along the truss
- A dynamic brake for speed control and a parking brake for use at work sites
- Energy absorbers to reduce the impact of a hard stop
- Three swing arms to provide access to structures alongside the truss
- An ORU transfer flat bed for attaching ORUs

ISS Electrical Power System

During STS-116, spacewalking astronauts performed the equivalent of rewiring the station's Electrical Power System (EPS). The astronauts, along with Boeing engineers and NASA mission controllers, orchestrated a precise ballet of powering down equipment, transferring it over to other redundant power channels, and then unplugging and plugging in electrical connectors.

The ISS power system was transitioned from its temporary system to its permanent configuration by rerouting power through electrical components on its port 1, starboard 0, and starboard 1 trusses for the first time. Like a city's central power plant, the station's giant solar arrays generate primary ISS power at levels too high for consumer use, ranging from 137 to 173 Vdc. The power is regulated between 150 to 160 volts, then routed to batteries for storage and to switching units that route it to distribution networks. The power coming from the solar arrays and batteries is called primary power.

The primary power is routed to the four main bus switching units located on the S0 truss. The MBSUs are fed by eight independent power channels (corresponding to each of the eight solar array wings), and the MBSUs output all ISS loads. Under normal operations, each power channel supplies power to a specific set of loads. However, if that channel fails, the MBSUs enable feeding power to those loads from another channel, which greatly enhances the fault tolerance of the EPS.

DC-to-DC converters "step-down" the primary 160-Vdc electricity to a more tightly regulated secondary power of 124.5 Vdc and distribute it to individual users. On Main Street USA, the users would be shops and homes. On the ISS, they are laboratories, living quarters, and the like. This secondary power feeds all the loads on the station. Most "electronics" such as laptops within the labs, nodes, airlocks, and living areas use even lower voltage stepped down via power supplies.

The space shuttle and most other spacecraft operate at 28 Vdc, as does the Russian ISS segment, which has its own two sets of solar arrays but can use and share U.S. power by using converters. The higher voltage of the U.S. power system will meet the higher overall ISS requirements for research as a test power bed for exploration while permitting use of smaller, lighter weight power lines. The higher voltage also reduces ohmic power losses through the wires.

Even though the station will spend about one-third of every orbit in the Earth's shadow, the electrical power system can continuously provide 84-120 kW of usable power to ISS systems using all eight solar array wings. Boeing's Rocketdyne Propulsion and Power division (now Hamilton Sundstrand) built most of the EPS hardware. Boeing, along with Hamilton Sundstrand as a subcontractor, provides EPS sustaining engineering support to NASA.

Active Thermal Control System Overview

Most of the station's many systems produce waste heat, which needs to be transferred from the ISS to space to achieve thermal control and maintain electrical components at acceptable temperatures. An Active Thermal Control System (ATCS) is required to achieve this heat rejection function when the combination of the ISS external environment and the generated heat loads exceeds the capabilities of the Passive Thermal Control System to maintain temperatures. An ATCS uses a mechanically pumped fluid in closed-loop circuits to perform three functions: heat collection, heat transportation, and heat rejection. Waste heat is removed in two ways: through coldplates and heat exchangers, both of which are cooled by circulating ammonia loops on the outside of the station. Ammonia is used because of its low freezing point. The heated ammonia circulates through large radiators located on the exterior of the ISS, releasing the heat by radiation to space that cools the ammonia as it flows through the radiators.

The ATCS consists of the Internal Active Thermal Control System (IATCS), External Active Thermal Control System (EATCS), Photovoltaic Thermal Control System (PVTCS), and Early External Active Thermal Control System (EE-ATCS). The IATCS consists of loops that circulate water through the interior of the U.S. Laboratory module to collect the excess heat from electronic and experiment equipment and distributes this heat to the interface heat exchangers for transfer to the EATCS. At assembly complete, there will be nine separate IATCS water loops in the U.S. and international partner pressurized modules.

The Photovoltaic Thermal Control System (PVTCS) consists of ammonia loops that collect excess heat from the Electrical Power System (EPS) components in the Integrated Equipment Assembly (IEA) on P4 and S4 and transport this heat to the PV radiators (located on P4, P6, S4, and S6) where it is rejected to space. The PVTCS consists of ammonia coolant, 11 coldplates, two pump flow control subassemblies (PFCS), and one photovoltaic radiator (PVR).

The External Active Thermal Control System (EATCS), activated for the first time on STS-116, consists of ammonia loops to collect heat from the interface heat exchangers and external electronic equipment mounted on coldplates and transports it to the S1 and P1 radiators where it is rejected to space. In lieu of using the EATCS initially, the station hardware has been cooled by the Early External Active Thermal Control System (EEATCS). The EEATCS provided heat rejection capability for the U.S. Laboratory interface heat exchangers (IFHX) from assembly flight 5A through 12A.1.

The EEATCS is the temporary system used to collect, transport, and reject waste heat from habitable volumes on the station. The EEATCS collects heat from the IFHX located on the U.S. Laboratory module, circulates the working fluid, anhydrous ammonia, via the pump and flow control subassembly (PFCS), and rejects heat to space via two orthogonally oriented stationary radiators.

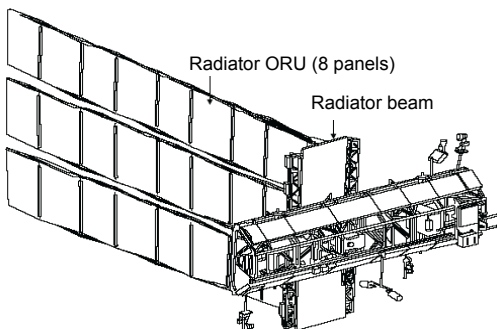

Note: All three radiators shown deployed.

ISS Flight Software

Flight software on board the ISS runs autonomously for the most part and provides critical functionality to maintain station life support systems, navigation and control, and communications with both the ground and the onboard crew.

Nothing on the station moves unless it is told by the software to do so. For the ISS to maintain orbital altitude, commands from the Russian segment computer tell thrusters on the Service Module or attached Progress supply ship to fire. For the giant solar arrays to track the sun, commands are sent from the U.S. computers responsible for the power generation function. For the station robotic arm to reach out and grapple a nearby element alongside the station, commands are sent from the Canadian robotics computers.

Not only the big moving parts but also the unseen equipment responsible for life support—oxygen generation equipment, water processors, carbon dioxide removal equipment, and scores of other devices—are monitored and commanded by the multitude of onboard computers.

This software has been built in countries around the globe—Russia, Germany, France, Canada, Italy, Japan, and the United States—by the various partner space agencies and their contractors. Currently, more than 50 dedicated computers, plus a score of crew member laptop

computers, are interconnected across a very large network to provide critical command and control functions. In all, there are about 7.5 million source lines of software code resident on these computers, even if one does not count the more common Microsoft operating systems and applications running on the crew laptops.

Software development for the ISS is a unique challenge because it is an international effort, brought together on orbit in a phased manner and built to the most exacting standards to ensure crew safety. Software within each computer is qualified at the site where developed, and then further integrated testing is performed in Houston with all associated partner software. This NASA facility, the International Space Station Software Development and Integration Laboratory, sits alongside the large Neutral Buoyancy Pool where astronauts train for their missions. The laboratory provides the ability to test the integrated station software in an environment as close as possible to the real one on orbit. To the maximum extent possible, the laboratory uses flight-equivalent computers, power, and wiring connections to ensure that the system timing and interface conditions will be realistic. This exactness is a necessity, as the software must work correctly from the first moment it becomes operational on orbit. Failure of the software could pose a risk to crew safety and continued station operations. The station community is especially proud that, as a consequence of its rigorous development methodology, ISS software quality is world class, achieving a 6 sigma error-free standard.

The success of this endeavor can be attributed to a number of factors, not the least of which is the dedication and hard work of professionals around the world who share a passion for spaceflight and exploration. A more practical reason, though, is the carefully considered architecture, and development methodology, which allowed each of the partner elements to come online over a span of years. Building a functioning space station is a bit like having to construct a giant industrial facility over a 10- or 15-year period, without ever having the benefit to integrate and test all the pieces together until each piece individually becomes operational. It was a robust computing architecture, and a world-class testing facility in Houston, that allowed those passionate professionals to be successful.

Breathing on the ISS

Life support systems on the ISS must not only supply oxygen and remove carbon dioxide from the cabin's atmosphere but also prevent gases like ammonia and acetone, which astronauts emit themselves in small quantities, from accumulating. Vaporous chemicals from equipment offgassing and science experiments are a potential hazard, too, if they combine in unforeseen ways with other elements in the air supply. So while air in space

is undeniably rare, managing it is no small problem. To ensure the safety of the crew, the ISS has redundant supplies of that essential gas—oxygen. Most of the station's oxygen comes from a process called “electrolysis,” which uses electricity from the ISS solar panels that powers a device to split water into oxygen and hydrogen gases. Each molecule of water contains two hydrogen atoms and one oxygen atom. Running a current through water causes these atoms to separate and recombine as gaseous oxygen (O₂) and hydrogen (H₂). The oxygen that people breathe on Earth also comes from the splitting of water, but it is not a mechanical process. Plants, algae, cyanobacteria, and phytoplankton all split water molecules as part of photosynthesis—the process that converts sunlight, carbon dioxide, and water into sugars for food. Oxygen is a byproduct of this process and is released into the atmosphere. Eventually, it would be great if plants could be used to produce oxygen for the station. However, the chemical-mechanical systems are much more compact, less labor intensive, and more reliable than a plant-based system. A plant-based life support system design is presently at the basic research and demonstration stage of maturity, and there are myriad challenges that must be overcome to make it viable.

Hydrogen that is left over from splitting water will be vented into space, at least at first. The space station's Environmental Control and Life Support (ECLS) System includes a machine that combines hydrogen with excess carbon dioxide from the air in a chemical reaction that produces water and methane. This water helps replace the water used to make oxygen, and methane is vented into space. Various uses for methane are being considered, including expelling it to help provide the thrust necessary to maintain the ISS orbit. At present, all of the venting that goes overboard is designed to be nonpropulsive to avoid disturbing the station's attitude.

The ISS also has large tanks of compressed oxygen and nitrogen mounted on the outside of the airlock module. These tanks serve as the primary supply of oxygen for the U.S. spacesuits and backup oxygen for the crew.

Another source of oxygen can come from “perchlorate candles,” which produce O₂ via chemical reactions inside a metal canister. A “perchlorate candle” is a metal canister with perchlorate packed inside it. A canister has an igniter pin. When this pin is struck, the reaction starts. Perchlorate continues to burn until it is all used. Each canister releases enough oxygen for one person for one day.

The air in the space station is kept in constant motion, and all the air passes through filters—called High-Efficiency Particle Air (HEPA) filters—on its way to the temperature and humidity control systems. The filters were originally designed to remove particulates, and they are very good at removing small particles and microbes. Microbes can

ride in the air on particles of dust or in tiny clumps of fungi. The humidity of the air in the station is maintained at 65 to 70 percent. Controlling the humidity is an effective way of discouraging microbe growth, and the temperature is a fairly constant 72°F on board.

Water on the ISS

Rationing and recycling is an essential part of daily life on the ISS. In orbit, where Earth's natural life support is missing, the space station itself has to constantly provide abundant power, clean water, and breathable air at the right temperature and humidity. The space station's ECLS helps astronauts use and reuse their precious supplies of water. This regenerative system can recycle almost every drop of water on the station and support a crew of six with minimal resupplies.

The ECLS Water Recovery System (WRS) reclaims waste waters from the station's humidity condensate, from urine and flush water, and from oral hygiene and hand washing. Without such careful recycling, 40,000 pounds of water per year from the Earth would be required to resupply a minimum of four crew members to live on the station, but it is very expensive to ferry water from Earth.

Water leaving the space station's purification machines is cleaner than what most of us drink on Earth. The station's water is practically ultra-pure by the time the water's purification process is finished, and the reason is that the ISS has a much more aggressive water treatment process than municipal wastewater treatment plants. The water purification machines on the ISS cleanse wastewater in a four-step process. The first step is a filter that removes particles and debris. Then the water passes through the "multifiltration beds," which contain substances that remove organic and inorganic impurities. After that, the "catalytic oxidation reactor" removes volatile organic compounds and kills bacteria and viruses by heating the water to as much as 265°F. And finally, the water is treated with iodine. As a result of such disinfection, there should be fewer than 100 microbes in 100 milliliters of water.

Once the water is purified, astronauts do everything possible to use it efficiently. On the ground, people flick on the faucet, and they probably waste a couple of liters of water just because it is free and the water pressure is high. On the ISS, the water pressure is about half what we might experience in a typical household. Astronauts do not use faucets on the ISS; they use a washcloth. It is much more efficient. If you are an astronaut, you will wet the washcloth with a spray nozzle and then use the cloth to wash your hands. On the space station, astronauts wash their hands with less than one-tenth of the water that people normally use on Earth. Instead of consuming 50 liters of water to take a shower, which is typical on Earth, astronauts on the ISS use less than four liters to bathe.

However, even with intense conservation and recycling efforts, the station gradually loses water because of inefficiencies in the life support system. The station will always need resupply because none of the water reprocessing technology that is available right now for space flight is 100 percent efficient, and there is always some loss. Lost water is replaced by carrying it over from the space shuttle or from the Russian Progress unmanned resupply vehicle. The shuttle produces water as its fuel cells combine hydrogen and oxygen to create electricity, and the Progress can be outfitted to carry large containers of water.

NASA scientists continue to look for ways to improve the life support systems of the ISS, reducing water losses and finding ways to reuse other waste products. If the water recycling systems can be improved to an efficiency of greater than about 95 percent, then the water contained in the station's food supply would be enough to replace the lost water. This is the next generation of water processing systems. They are being developed now, but they are not ready for space flight yet.

Housekeeping on the ISS

Living in space is a daring adventure, but somebody still has to cook dinner and take out the trash. What does the ISS crew eat, and how is it cooked? All food is delivered by the U.S. space shuttle or the Russian Progress vehicle, the European Automated Transfer Vehicle (ATV), or Japanese HII Transfer Vehicle (HTV). The crew helps select the foods they want from a wide-ranging menu. Food aboard the space station comes in several forms. Most of the food is processed and packaged in pouches or cans. Some food is dehydrated, and the astronauts add hot water and eat. A small amount is fresh food that includes fruits and vegetables but nothing that requires refrigeration. All food is stored at room temperature.

Water recycling efficiencies of greater than 95 percent are the goal. But other wastes cannot be recycled so efficiently, particularly solid waste from food containers, experiments, empty equipment containers, and other ISS activities. So: Who takes out the trash? Again, Progress and the space shuttle come to the rescue. Every arrival of the shuttle brings fresh supplies. And when it leaves, it becomes the world's most expensive trash hauler. Bags and containers of sealed trash are brought back to Earth. More exciting, perhaps, is how the Russian Progress disposes of trash. Again, when it arrives, it brings fresh supplies (but no crews, since it is just a supply vehicle). And when the fresh supplies are unloaded, the trash bags are piled in, and the Progress is sealed. After it disconnects from the ISS, it is placed into a lower orbit and makes a controlled reentry during which it and the trash are incinerated over the ocean. The same is true for the ATV and HTV resupply vehicles now in use.

Relaxation and Recreation on the ISS

Crews are always busy during their tours of duty on the ISS. Nevertheless, relaxation and recreation for the men and women living aboard the space station play a very important role. A significant portion of nonworking time is taken up in a stiff regimen of exercise and physical activity by using a bicycle, rowing machine, treadmill, and various other equipment. Data from the ISS and other previous long-duration flights show that significant physical degradation of the human body occurs in space. The human body was really designed to function in a one-G gravitational field. Fluid loss, loss of muscle tissue, loss of bone mass, and changes in cardiovascular system and other organs all take place in zero-G. And the longer people stay there, the more significant the changes become. However, the good news is that the changes are reversible after return to Earth, and an active program of strenuous exercise in space can reduce these changes.

But what are the individual crew members doing when they are not working, exercising, or sleeping? Astronauts like to have fun, too. For space workers who stay on the ISS for many months, fun is an essential ingredient to the quality of their lives. Astronauts can take a certain amount of personal gear up with them. Things like checkers or chess sets, CDs and MP3 players, and similar items are allowed. Crew members can listen to their favorite music or watch DVD movies. A popular pastime while orbiting the Earth is simply looking out the window, and the ISS has numerous windows. The Cupola, with its 360-degree viewpoint, is a crew favorite. Photography is a popular pastime. Astronauts often comment on their fascination and awe as they look at the Earth spin beneath them with its multiple shades and textures, and the spectacular sunsets and sunrises, occurring every 45 minutes above the Earth's atmosphere.

Russian Soyuz Spacecraft

The Russian Soyuz has been a long-lived, adaptable, and highly successful crewed spacecraft design. The Soyuz first flew in 1967 and has flown more than 100 flights. Versions have been developed for a wide variety of missions—Earth orbit science, circumlunar, lunar orbital, military interceptors, light space stations, free-flying man-tended laboratories, space station crewed ferries, and space station logistics vehicles.

A Soyuz space capsule brought the first crew to the ISS in November 2000. Since that time, at least one Soyuz has always been at the station. The Soyuz TMA spacecraft is designed to serve as the ISS crew return vehicle, acting as a lifeboat in the event an emergency would require the crew to leave the station. A new Soyuz capsule is normally delivered to the station by a taxi crew every six months; the taxi crew then returns to Earth in the older Soyuz capsule.

The Soyuz spacecraft is launched to the ISS from the Baikonur Cosmodrome in Kazakhstan in central Asia. The Soyuz consists of an orbital module, which includes the docking mechanism; an instrumentation/propulsion module; and a descent module, which is the only portion of the Soyuz that survives the return to Earth. A Soyuz trip to the station takes two days from launch to docking, but the return to Earth takes less than four hours. The rendezvous and docking are both automated; however, the Soyuz crew has the capability to manually intervene or execute these operations.

As many as three crew members can launch and return to Earth from the station aboard a Soyuz TMA spacecraft. The vehicle lands on the flat steppes of Kazakhstan.



A Soyuz spacecraft departs from the ISS, carrying a taxi crew.

Progress Spacecraft

The Progress resupply vehicle is an automated, uncrewed version of the Soyuz spacecraft and is used to bring supplies and fuel to the ISS. The Progress also has the ability to raise the station's altitude and control the orientation of the station using the vehicle's thrusters.

Both the Progress M and M1 versions have a pressurized cargo module that can carry up to 3,748 lb (1,700 kg) of supplies, a refueling module with eight propellant tanks that can hold up to 3,836 lb (1,740 kg) of fuel, and an instrumentation/propulsion module where the Progress systems equipment and thrusters are located.

The Progress spacecraft is launched from the Baikonur Cosmodrome in Kazakhstan aboard a Soyuz rocket. It normally docks to the end of the station's Zvezda service module, but it can also dock to the bottom of the Pirs Docking Compartment. The rendezvous and docking are both automated, although once the spacecraft is within 492 feet (150 meters) of the station, the Russian Mission Control Center just outside Moscow and the station crew monitor the approach and docking. The Progress uses an automated, radar-based system called Kurs (Russian for "course") to dock to the station. The station crew can also dock the Progress using the Telerobotically Operated Rendezvous Unit (TORU), a backup remote control docking system in the station's Zvezda service module.

After the cargo is removed and before the Progress undocks, the crew refills it with trash, unneeded equipment, and wastewater, which will burn up with the spacecraft when it re-enters the Earth's atmosphere.



An unmanned Progress spacecraft is seen from the ISS following its undocking.

H-II Transfer Vehicle

The H-II Transfer Vehicle (HTV) is an expendable, un-manned resupply spacecraft developed by the Japan Aerospace Exploration Agency (JAXA) and its industrial team, led by Mitsubishi Heavy Industries. HTVs are designed to supply the ISS with supplies, payloads, and experiments.

Russian Progress vehicles and ESA's ATV dock with the Russian segment of the ISS, which has smaller hatches than the U.S., European, and Japanese modules. Because the HTV is docked to one of these modules, it is designed with wider door openings that allow larger cargo to be moved into the station, giving the HTV the ability to bring with it large spare parts and science racks.

The Boeing ISS team in Huntsville, Ala., also worked with Mitsubishi Heavy Industries to design and assemble a passive common berthing mechanism (PCBM) used on the HTV that allows it to connect with the ISS.

Four main engines and 28 maneuvering jets fine-tune the HTV's approach to the ISS. Fifty-seven solar panels affixed to the HTV's exterior provide electricity for the craft.

The HTV does not have a complex docking-and-approach system. Instead, it is flown just close enough to the station to allow capture by Canadarm2, which pulls the HTV to a berthing port on the ISS Harmony module.



Backdropped by Earth, the unpiloted HTV-1 approaches the ISS.

HTVs can carry supplies in a combination of two different "segments" that can be attached together. The baseline configuration, known as the "Mixed Logistics Carrier," uses one pressurized and one unpressurized segment and can carry 13,228 lb (6,000 kg) of cargo in total. HTV is the first unmanned vehicle that can carry both pressurized and unpressurized cargo.

The pressurized segment has a capacity of 9,921 lb (4,500 kg), which includes an optional docking adapter at one end to allow it to be unloaded in a shirt-sleeve environment. Pressurized supplies are stored in Cargo Transfer Bags (CTBs) loaded inside eight filing cabinet-sized International Standard Payload Racks (ISPRs) attached to the walls of the HTV.

The HTV is designed specifically to carry eight ISPRs in total. After the retirement of the space shuttle, the HTV will be the only vehicle that can carry ISPRs to the ISS. The HTV also has a tank to deliver up to 661 lb (300 kg) of water to the station.

The other hold is a lighter and slightly longer unpressurized segment with a capacity of 3,307 lb (1,500 kg), which includes a hatch on the side to allow it to be unloaded remotely.

Length:	33 ft (10 m)
Width:	14 ft (4.4 m)
Weight:	21,000 lb (9,525 kg)

The first mission, HTV-1, was launched on Sept. 10, 2009, on an H-II/B launch vehicle from the Yoshinobu Launch Complex at the Tanegashima Space Center near the southernmost tip of Japan. The pressurized cargo consisted mainly of food, water, and clothing, while the unpressurized cargo contained two scientific experiments—Japan's Superconducting Submillimeter-Wave Limb Emission Sounder (SMILES) and the U.S. Naval Research Laboratory's HICO-RAIDS Experiment Payload (HREP). Both were subsequently installed on Kibo's Exposed Facility.

Six additional missions are planned, with HTV-2 scheduled for 2011.

Once its mission is complete, the HTV, filled with trash from the ISS to free up storage space, separates. Its thrusters move the spacecraft out of orbit and place it on a path to perform a controlled destructive reentry. HTV-1 burned up in the Earth's atmosphere on Nov. 2, 2009.

HTV missions are monitored and controlled by the HTV Mission Control Room (HTV MCR) at the Space Station Operations Facility (SSOF) in JAXA's Tsukuba Space Center (TKSC) in collaboration with NASA's Mission Control Center in Houston.

Automated Transfer Vehicle (ATV)

The ATV is an expendable, unmanned spacecraft developed by the European Space Agency (ESA). ATVs are designed to supply the ISS with propellant, food, water, air, and payloads. In addition, ATVs can reboost the station into a higher orbit. ATVs use a GPS and star tracker to automatically rendezvous with the ISS.

Like the Russian-built Progress, it carries cargo kept in a pressurized shirt-sleeve environment so astronauts can have access to it without putting on a spacesuit. The ATV cargo section is based on the Italian-built MPLM.

Height:	34 ft (10.3 m)
Diameter:	15 ft (4.5 m)
Cargo:	16,900 lb (7,667 kg)

The first ATV, Jules Verne, was launched in March 2008 atop an Ariane 5ES from the equatorial ELA-3 launch site at the Guiana Space Centre. ATV-001 was named in memory of French science fiction writer Jules Verne and carried two of the author's original handwritten manuscripts and a 19th century illustrated edition of his novel, *From the Earth to the Moon*, to be received by the ISS crew as symbolic tokens of the success of the first flight.



The Jules Verne ATV approaches the ISS.

ATVs are intended to be launched every 17 months to resupply the ISS. ESA has already contracted suppliers to produce four more. ATV-002, named for German astronomer Johannes Kepler, is scheduled to be launched in February 2011. ATV-003, named for Italian physicist Edoardo Amaldi, is in production.

Once its mission is accomplished, the ATV, filled with as much as 14,000 lb of waste, separates. Its thrusters move the spacecraft out of orbit and place it on a flight path to perform a controlled destructive reentry. The Jules Verne burnt up on Sept. 29, 2008, on entering the atmosphere above an uninhabited section of the Pacific Ocean.

ATV missions are managed by a combined ESA/CNES (Centre National d'Études Spatiales) mission operations team based at ESA's ATV Control Centre (ATV-CC) located at the Toulouse Space Centre (CST) in Toulouse, France.

ISS Flights to Date

1A/R:	Nov. 20, 1998
Launch Vehicle:	Russian Proton rocket
Elements:	Zarya control module (Functional Cargo Block—FGB)
Provided:	Early propulsion, power, fuel storage, communications
Current Duties:	Passageway, stowage facility, docking port, fuel tank
2A/STS-88:	Dec. 4, 1998
Launch Vehicle:	Space shuttle Endeavour
Elements:	Node 1 "Unity"; two pressurized mating adapters
Provided:	Unity—connecting points for Z1 truss/U.S. Laboratory, airlock, cupola, Node 3, Multi-Purpose Logistics Module, control module; PMA-1—connects U.S. and Russian elements; PMA-2—shuttle docking location
2A.1/STS-96:	May 27, 1999
Launch Vehicle:	Space shuttle Discovery
Elements:	SPACEHAB; logistics flight
Provided:	Resupply cargo; external Russian cargo crane used for spacewalking maintenance activities
2A.2a/STS-101:	May 19, 2000
Launch Vehicle:	Space shuttle Atlantis
Elements:	SPACEHAB double cargo module
Provided:	Internal logistics and resupply cargo. Four of six batteries were swapped to restore the electrical power system to full redundancy
1R:	July 12, 2000
Launch Vehicle:	Russian Proton rocket
Elements:	Zvezda service module
Provided:	Early station living quarters, life support, propulsive attitude control and reboost capability; docking port for Progress-type cargo resupply vehicles and Soyuz vehicles
2A.2b/STS-106:	Sept. 8, 2000
Launch Vehicle:	Space shuttle Atlantis
Elements:	SPACEHAB double cargo module
Provided:	Unloaded supplies from Progress; battery and voltage converter installation; connected power, data, and communications cables between the Zvezda and Zarya; installed treadmill; delivered toilet

3A/STS-92:	Oct. 11, 2000
Launch Vehicle:	Space shuttle Discovery
Elements:	Integrated truss structure (ITS) zenith 1 (Z1), Pressurized Mating Adapter-3 (PMA), Ku-band communications system, control moment gyros (CMGs)
Provided:	Z1 as early framework for first U.S. solar arrays (power); Ku-band communication system (science capability and U.S. television); nonpropulsive, electrically powered attitude control with CMG; PMA-3 provided shuttle docking port for solar array installation
2R:	Oct. 31, 2000
Launch Vehicle:	Russian Soyuz
Elements:	Expedition 1 Crew
Established:	First permanent human presence in space with three-person crew: commander Bill Shepherd, Soyuz commander Yuri Gidzenko, flight engineer Sergei Krikalev. Crew on board for four months; relieved by Expedition 2 crew on STS-102
Activities:	Performed flight test, checked out communications systems, charged batteries for power tools, started water processors, activated life support systems, began scientific experiments
4A/STS-97:	Nov. 30, 2000
Launch Vehicle:	Space shuttle Endeavour
Elements:	Port 6 (P6) truss structure, photovoltaic module, radiators
Provided:	First U.S. solar power with solar arrays and batteries (photovoltaic module), two radiators for early cooling, S-band communications system activated for voice and telemetry
5A/STS-98:	Feb. 7, 2001
Launch Vehicle:	Space shuttle Atlantis
Elements:	U.S. Laboratory "Destiny"
Provided:	Destiny is the centerpiece of ISS, where unprecedented science experiments are performed. It contains five system racks and provided initial U.S. user capability. Control moment gyroscopes activated for electrically powered attitude control

5A.1/STS-102:	March 8, 2001
Launch Vehicle:	Space shuttle Discovery
Elements:	Leonardo Multi-Purpose Logistics Module (MPLM) carried equipment racks
Provided:	Logistics and resupply; pressurized MPLMs served as station's "moving vans" and carried new laboratory racks filled with equipment, experiments and supplies and returned old racks and experiments to Earth
Established:	Second resident crew, Expedition 2, to the station: commander Yury Usachev and flight engineers James Voss and Susan Helms. Returned Expedition 1 crew to Earth
6A/STS-100:	April 19, 2001
Launch Vehicle:	Space shuttle Endeavour
Elements:	Raffaello MPLM carried equipment racks; ultra-high frequency (UHF) antenna; Space Station Remote Manipulator System (SSRMS)
Provided:	Installation, activation, and check-out of the SSRMS robotic arm (Canadarm2), which was critical to the continuing assembly of the ISS
7A/STS-104:	July 12, 2001
Launch Vehicle:	Space shuttle Atlantis
Elements:	Joint airlock "Quest"; high-pressure gas tanks (two oxygen and two nitrogen) installed on the airlock
Provided:	Installation, checkout, and first use of the joint airlock, which supports the use of either U.S. spacesuits or Russian Orlan spacesuits during spacewalks
7A.1/STS-105:	Aug. 14, 2001
Launch Vehicle:	Space shuttle Discovery
Elements:	Leonardo MPLM carried equipment racks
Provided:	Logistics and resupply
Established:	Third resident crew, Expedition 3, to the station: commander Frank Culbertson and flight engineers Vladimir Dezhurov and Mikhail Tyurin. Returned Expedition 2 crew to Earth

UF-1/STS-108:	Dec. 5, 2001
Launch Vehicle:	Space shuttle Endeavour
Elements:	Raffaello MPLM carried equipment racks, STARSHINE 2 satellite
Established:	Fourth resident crew, Expedition 4, to the station: commander Yuri Onufrienko and flight engineers Daniel Bursch and Carl Walz. Returned Expedition 3 crew to Earth
8A/STS-110:	April 8, 2002
Launch Vehicle:	Space shuttle Atlantis
Elements:	Starboard 0 (S0) central integrated truss structure; mobile transporter, which was attached to the mobile base system during mission STS-111 to create the first "railroad in space"
UF-2/STS-111:	June 5, 2002
Launch Vehicle:	Space shuttle Endeavour
Elements:	Leonardo MPLM carried equipment racks; mobile base system (MBS)
Provided:	Repaired wrist roll joint on Canadarm2; installed MBS to mobile transporter, previously delivered on STS-110, which completed the Mobile Servicing System. The Mobile Servicing System provides greater mobility to Canadarm2, allows the transport of payloads across the ISS, and aids the crew in spacewalks
Established:	Fifth resident crew, Expedition 5, to the station: commander Valery Korzun and flight engineers Peggy Whitson and Sergei Treschev. Returned Expedition 4 crew to Earth. Expedition 4 crew members Carl Walz and Daniel Bursch set new record for longest U.S. space flight (196 days), breaking the previous record of 188 days in space held by Shannon Lucid aboard the Russian space station Mir. Walz then set the U.S. record for the most cumulative time in space with 231 days.
9A/STS-112:	Oct. 7, 2002
Launch Vehicle:	Space shuttle Atlantis
Elements:	Starboard 1 (S1) truss
Provided:	The S1 truss contained a new external cooling system for the station that was activated on a later mission; also, a second S-band

communications system provided enhanced and extended voice and data capability; the Crew and Equipment Translation Aid (CETA) cart that serves as a mobile work platform for spacewalkers; two new external television cameras; and the first thermal radiator rotary joint (TRRJ), which provides the mechanical and electrical energy for rotating the station's heat-rejecting radiators. The S1 truss enables the station to begin the outboard expansion of its rail system in preparation for the addition of new power and science modules in the years to come.

11A/STS-113: Launch Vehicle: Elements:	Nov. 23, 2002 Space shuttle Endeavour Port 1 (P1) truss and Crew and Equipment Translation Aid (CETA) cart
Provided:	The P1 truss, which was preintegrated with ultra-high frequency (UHF) communication equipment, thermal radiator rotary joint (TRRJ), three external active thermal control system (EATCS) radiators, direct current (DC)-to-DC converter unit (DDCU), remote power controller module (RPCM), nitrogen tank assembly (NTA), ammonia tank assembly (ATA), and pump module assembly (PMA)
Established:	Sixth resident crew, Expedition 6, to the station: commander Kenneth Bowersox, flight engineer Nikolai Budarin, and science officer Donald Pettit. Returned Expedition 5 crew to Earth
LF1/STS-114: Launch Vehicle: Elements:	July 26, 2005 Space shuttle Discovery Raffaello MPLM carried equipment racks
Provided:	Test of orbiter boom sensor system (OBSS), test and evaluation of thermal protection system (TPS) repair techniques, replaced one ISS control gyroscope and restored power to a second gyroscope, installed work platform on ISS for future construction

ULF1.1/STS-121:	July 4, 2006
Launch Vehicle:	Space shuttle Discovery
Elements:	Leonardo MPLM carried equipment racks
Provided:	Additional test of orbiter boom sensor system (OBSS), additional test and evaluation of thermal protection system (TPS) repair techniques, replaced trailing umbilical system–reel assembly (TUS-RA) to restore station’s mobile robotic system to full operation
Re-established:	Three-person ISS crew for the first time since May 2003
12A/STS-115:	Sept. 9, 2006
Launch Vehicle:	Space shuttle Atlantis
Elements:	Port 3 and 4 (P3/P4) truss
Provided:	The P3 and P4 trusses were attached to the P1 truss and provided an attachment point for P5. The P3 and P4 trusses also provided a second set of solar array wings (SAWs) and the first alpha joint. The segments support utility routing, power distribution, and a translation path for the mobile base system (MBS). Major P3 subsystems included the segment-to-segment attach system (SSAS), solar alpha rotary joint (SARJ), and unpressurized cargo carrier attach system (UCCAS). Major P4 subsystems include the photovoltaic radiator (PVR), alpha joint interface structure (AJIS), modified Rocketdyne truss attachment system (MRTAS), and integrated equipment assembly (IEA).
12A.1/STS-116	Dec. 9, 2006
Launch Vehicle:	Space shuttle Discovery
Element:	Port 5 (P5) truss
Provided:	The P5 is used primarily to connect power and cooling lines and serve as a spacer between the P4 and P6 photovoltaic modules. The girder-like structure provided several extravehicular aids, robotic interfaces, ammonia servicing hardware, and also accommodates an external storage platform. P5 contains a remote sensor box, two tri-axial accelerators and two antenna assemblies as part of the External Wireless Instrumentation System (EWIS). P5 also has white thermal blankets on the structure, which help shade the P4 solar array assembly ORUs.

13A/STS-117	June 8, 2007
Launch Vehicle:	Space shuttle Atlantis
Element:	Starboard 3 and 4 (S3/S4) truss
Provided:	The principal functions of the S3 and S4 truss segments are to provide electrical power and data interfaces for future mission payloads and convert sunlight to electricity. The segments included another set of solar array wings (SAWs) and a second solar alpha rotary joint (SARJ), which keeps the arrays permanently pointed toward the sun. Beside two SAWs and a SARJ, the S3/S4 structure has several distinct elements: the integrated equipment assembly (IEA), two beta gimbal assemblies (BGAs), and the photovoltaic thermal control subsystem (PVTCS).
13A.1/STS-118	Aug. 8, 2007
Launch Vehicle:	Space shuttle Endeavour
Element:	Starboard 5 (S5) truss
Provided:	The S5 is used primarily to connect power, cooling lines, and serve as a spacer between the S4 photovoltaic module (PVM) and S6 PVM, which were joined during a later assembly mission. S5 is very similar in construction to the long spacer located on S6. Without the S5 short spacer, the S4 and S6 solar arrays would not be able to connect because of the way the photovoltaic arrays (PVAs) are deployed on orbit.
10A/STS-120	Oct. 23, 2007
Launch Vehicle:	Space shuttle Discovery
Element:	Node 2 "Harmony"
Provided:	Harmony added 2,666 cubic feet of living and working space to the complex, increasing the station's living space by nearly 20%. It serves as the permanent docking port for international laboratories from the ESA and JAXA. During STS-120, the crew installed Harmony in a temporary location and relocated the P6 truss segment and solar arrays to the end of the P5 truss, then redeployed and reactivated the P6 arrays. The Expedition 16 crew used Canadarm2 to move and install Harmony to its permanent location on the front of the Destiny laboratory after the shuttle departed.

1E/STS-122	Feb. 7, 2008
Launch Vehicle:	Space shuttle Atlantis
Element:	Columbus Laboratory
Provided:	Columbus added 2,646 cubic feet of space to the ISS. It was the first European laboratory dedicated to long-term research in space and offers internal and external accommodations for numerous experiments in life sciences, fluid physics, and a host of other disciplines.
1J/A/STS-123	March 11, 2008
Launch Vehicle:	Space shuttle Endeavour
Element:	Kibo Japanese Experiment Logistics Module—Pressurized Section (ELM-PS) and Canadian Special Purpose Dexterous Manipulator (Dextre)
Provided:	The ELM-PS marked the beginning of JAXA's presence on the ISS. ELM-PS is the smaller of two pressurized Japanese modules. Combined with other elements delivered on shuttle missions STS-124 and STS-127, they make up Kibo, the station's largest science laboratory. The addition of Dextre allows astronauts to replace hardware outside the station without doing a spacewalk.
1J/STS-124	May 31, 2008
Launch Vehicle:	Space shuttle Discovery
Element:	Kibo Japanese Experiment Module—Pressurized Module (JEM-PM) and Japanese Experiment Module Remote Manipulator System (JEMRMS)
Provided:	The STS-124 mission was the second of three flights launching components to complete the Kibo laboratory. This mission delivered the JEM-PM, the central part of Kibo, the station's largest science laboratory, and the main arm of the JEMRMS.
ULF2/STS-126	Nov. 14, 2008
Launch Vehicle:	Space shuttle Endeavour
Element:	Leonardo MPLM
Provided:	The STS-126 mission had two equally important goals: to deliver equipment—sleep stations, a new galley, an advanced resistive exercise device, and a water recovery

Provided (Cont'd): system—that allowed the station to double its crew size to six; plus the repair and maintenance of the Solar Alpha Rotary Joints, which rotate the ISS's solar arrays to keep them facing the sun for maximum production of electricity.

15A/STS-119 March 15, 2009
Launch Vehicle: Space shuttle Discovery
Element: Starboard 6 (S6) truss
Provided: The STS-119 mission delivered the fourth set of solar arrays and batteries, completing the truss system and doubling the amount of electricity available for science operations.

2J/A/STS-127 July 15, 2009
Launch Vehicle: Space shuttle Endeavour
Element: Kibo Japanese Experiment Module Exposed Facility (JEM EF); Kibo Japanese Experiment Logistics Module–Exposed Section (ELM–ES)
Provided: The JEM-EF is a part of Kibo that allows astronauts to perform science experiments that are exposed to the vacuum of space. The ELM-ES is similar to the ELM-PS logistics module on Kibo but is not pressurized. Once its payloads are transferred to the JEM-EF, the ELM-ES is returned to the space shuttle's payload bay.

17A/STS-128 Aug. 28, 2009
Launch Vehicle: Space shuttle Discovery
Element: Leonardo MPLM; Lightweight Multipurpose Carrier with Ammonia Tank Assembly
Provided: Leonardo carried more than 16,000 pounds of supplies and equipment, including the Combined Operational Load Bearing External Resistance Treadmill (COLBERT); Fluids Integrated Rack, Materials Science Research Rack–1 and Minus Eighty-Degree Laboratory Freezer for ISS; and new crew quarters for Robert Thirsk.

ULF3/STS-129	Nov. 16, 2009
Launch Vehicle:	Space shuttle Atlantis
Element:	ExPRESS Logistics Carrier 1 and 2 (ELC1 and ELC2)
Provided:	ELC1 and ELC2 carried numerous orbital replacement units too big to fly in any of the vehicles that will be left when the space shuttle retires, such as control moment gyroscopes, a battery charge discharge unit, a plasma contactor unit, nitrogen tanks, cooling system pump module assemblies, high-pressure gas tanks, ammonia tanks, a latching end effector for the station's robotics, and a trailing umbilical system reel assembly.
20A/STS-130	Feb. 8, 2010
Launch Vehicle:	Space shuttle Endeavour
Element:	Node 3 "Tranquility" and its attached Cupola
Provided:	Tranquility functions as a utility room for the ISS, housing large refrigerator-size racks of equipment, and serving as the home for the station's robotic arm controls, life support systems, and exercise gear, including the COLBERT treadmill. One of Tranquility's many connection ports is occupied by the Cupola, a seven-window addition that gives astronauts a panoramic view of Earth, outer space, and visiting spacecraft.
19A/STS-131	April 5, 2010
Launch Vehicle:	Space shuttle Discovery
Element:	Leonardo MPLM
Provided:	Leonardo carried more than 17,000 pounds of supplies, four equipment racks, and the final private crew sleeping quarters.
ULF4/STS-132	May 14, 2010
Launch Vehicle:	Space shuttle Atlantis
Element:	Integrated Cargo Carrier (ICC); Mini-Research Module 1 (MRM1)
Provided:	Last shuttle delivery of an ISS module, MRM1, as well as additional spare parts, including a set of batteries for the station's truss and a high-powered dish antenna assembly

Extravehicular Mobility Unit

The space shuttle and ISS extravehicular mobility unit (EMU), or spacesuit, has dramatically enabled humans to work effectively in space. Extravehicular activity (EVA), or spacewalk, highlights include the refueling and repair of satellites on orbit, retrieval of satellites for refurbishment on Earth, and the assembly of the ISS. The EMU has and will continue to play a vital role in allowing America's space shuttle to fulfill a wide spectrum of space tasks such as inspection, maintenance, repair, construction, and, if necessary, rescue operations.



Hamilton Sundstrand Space Systems International provides the EMU for NASA. The 394-lb EMU is modularized to fit astronauts and serves as a one-person spacecraft, providing protection and Earth-like mobility for EVA astronauts. It is constructed of a urethane-coated nylon pressure bladder; orthofabric and aluminized mylar thermal/meteoroid garment; fiberglass hard upper torso; ball-bearing joints (arm, wrist, leg); and polycarbonate helmet and visors. It provides a suit operating pressure of 4.3 psid in an operating environment ranging from 0 psia to 14.7 psia for as many as seven hours.

Spacesuit assembly (SSA) provides:

- Atmosphere containment
- High-mobility and low-torque body joints
- Thermal insulation
- Cooling distribution
- Waste collection
- Sunlight and solar radiation protection

-
-
- Micrometeoroid and debris protection
 - Simple on-orbit resizing capability

Life Support System (LSS) provides:

- Oxygen supply
- Suit pressurization and ventilation
- Communications
- Breathing gas purification
- Temperature control
- Independent emergency life support for up to 30 minutes
- Orbital Replaceable Unit (ORU) capability

For safety, the EMU is constantly monitored by a Caution and Warning System (CWS), which monitors 17 sensors, contaminant levels, and remaining expendables such as oxygen, water, and power.

EVAs (as of October 2010)

<u>Flight</u>	<u>No. of EVAs</u>	<u>Duration</u>
STS-88	3	21 hr, 22 min
STS-96	1	7 hr, 55 min
STS-101	1	6 hr, 44 min
STS-106	1	6 hr, 14 min
STS-92	4	27 hr, 19 min
STS-97	3	19 hr, 20 min
STS-98	3	19 hr, 48 min
STS-102	2	15 hr, 16 min
STS-100	2	14 hr, 50 min
STS-104	2	12 hr, 25 min
STS-105	2	11 hr, 45 min
STS-108	1	4 hr, 12 min
STS-114	3	20 hr, 05 min
STS-121	3	21 hr, 29 min
STS-115	3	20 hr, 19 min
STS-116	4	25 hr, 45 min
STS-117	4	27 hr, 58 min
STS-118	4	23 hr, 15 min
STS-120	4	27 hr, 14 min
STS-122	3	22 hr, 08 min
STS-123	5	33 hr, 28 min
STS-124	3	20 hr, 32 min
STS-126	4	26 hr, 41 min
STS-119	3	19 hr, 04 min
STS-127	5	30 hr, 30 min
STS-128	3	20 hr, 15 min
STS-129	3	18 hr, 27 min
STS-130	3	18 hr, 14 min
STS-131	3	20 hr, 17 min
STS-132	3	21 hr, 20 min
Total shuttle-based	28	187 hr, 15 min
Total ISS-based	122	757 hr, 09 min
Total to date	150	944 hr, 24 min

Future ISS Assembly Schedule (subject to change)

Date	Assembly Flight	Launch Vehicle	Element(s)
Targeted for Nov. 2010	ULF5	Discovery (OV-103) STS-133	<ul style="list-style-type: none"> • ExPRESS Logistics Carrier 4 (ELC4) • Pressurized Multipurpose Module (PMM)
Targeted for Feb. 2011	ULF6	Endeavour (OV-105) STS-134	<ul style="list-style-type: none"> • ExPRESS Logistics Carrier 3 (ELC3) • Alpha Magnetic Spectrometer (AMS)
Targeted for June 2011	TBD	Atlantis (OV-104) STS-135	<ul style="list-style-type: none"> • Multi-Purpose Logistics Module (MPLM) Raffaello • Lightweight Multi-Purpose Carrier (LMC)
Targeted for Dec. 2011	3R	Russian Proton	<ul style="list-style-type: none"> • Multipurpose Laboratory Module with European Robotic Arm (ERA)
<p>Note: Additional Progress, Soyuz, and European Automated Transfer Vehicle flights for crew transport, logistics, and resupply are not listed.</p>			

EXPEDITION CREWS

Human space flight history continues to be written each day aboard the International Space Station with the continued human presence of each Expedition crew.

ISS began a new era in exploration by allowing humans to take up permanent residence in space. Many questions about how to sustain life in outer space were previously answered during NASA's experience with the Shuttle/Mir program. This knowledge, combined with the discoveries of the astronauts and cosmonauts living on board ISS, will greatly increase our understanding of what it is like living in space.

The crews rotate during crew exchange flights. During the hand-over period, the current space station crew members communicate by conference call to the new crew members any rare situations they have dealt with, any new techniques they have learned, or any information that might be helpful to the new residents. Once the new crew members actually arrive, the outgoing crew will brief them on safety, vehicle changes, and payload operations.

The current habitable pressurized volume on the ISS is 31,509 cubic feet (892 cubic meters). The habitable pressurized volume on the completed station will be 34,700 cubic feet (983 cubic meters), roughly equivalent to the interior of a Boeing 747.

Expedition 1

Mission:	ISS Flight 2R
Vehicle:	Soyuz TM-31
Launched:	Oct. 31, 2000, from Baikonur Cosmodrome in Kazakhstan
Crew:	ISS commander Bill Shepherd Soyuz commander Yuri Gidzenko Flight engineer Sergei Krikalev
Returned:	March 21, 2001, aboard STS-102 (Discovery)
Duration:	141 days

Expedition 2

Mission:	STS-102/ISS Flight 5A.1
Vehicle:	Space shuttle Discovery
Launched:	March 8, 2001, from Kennedy Space Center, Pad 39B
Crew:	ISS commander Yury Usachev Flight engineer James Voss Flight engineer Susan Helms
Returned:	Aug. 22, 2001, aboard STS-105 (Discovery)
Duration:	167 days

Expedition 3

Mission: STS-105/ISS Flight 7A.1
Vehicle: Space shuttle Discovery
Launched: Aug. 10, 2001, from Kennedy
Space Center, Pad 39A
Crew: ISS commander Frank Culbertson Jr.,
Soyuz commander Vladimir Dezhurov
Flight engineer Mikhail Tyurin
Returned: Dec. 17, 2001, aboard STS-108
(Endeavour)
Duration: 129 days

Expedition 4

Mission: STS-108/ISS Flight UF-1
Vehicle: Space shuttle Endeavour
Launched: Dec. 5, 2001, from Kennedy Space
Center, Pad 39B
Crew: ISS commander Yury I. Onufrienko
Flight engineer Daniel W. Bursch
Flight engineer Carl E. Walz
Returned: June 19, 2002, aboard STS-111
(Endeavour)
Duration: 196 days

Expedition 5

Mission: STS-111/ISS Flight UF-2
Vehicle: Space shuttle Endeavour
Launched: June 5, 2002, from Kennedy Space
Center, Pad 39A
Crew: ISS commander Valery G. Korzun
ISS science officer
Peggy A. Whitson
Flight engineer Sergei Y. Treschev
Returned: Dec. 7, 2002, aboard STS-113
(Endeavour)
Duration: 185 days

Expedition 6

Mission: STS-113/ISS Flight 11A
Vehicle: Space shuttle Endeavour
Launched: Nov. 23, 2002, from Kennedy
Space Center, Pad 39A
Crew: ISS commander
Kenneth D. Bowersox
Flight engineer Nikolai M. Budarin
ISS science officer Donald R. Pettit
Returned: May 3, 2003, aboard Soyuz TMA-1
Duration: 161 days

Expedition 7

Vehicle: Soyuz TMA-2
Launched: April 25, 2003, from Baikonur
Cosmodrome in Kazakhstan
Crew: ISS commander Yuri I. Malenchenko
Flight engineer/science officer
Edward T. Lu
Returned: Oct. 27, 2003, aboard Soyuz TMA-2
Duration: 185 days

Expedition 8

Vehicle: Soyuz TMA-3
Launched: Oct. 18, 2003, from Baikonur
Cosmodrome in Kazakhstan
Crew: ISS commander/science officer
C. Michael Foale
Flight engineer Alexander Y. Kaleri
Flight engineer Pedro Duque
(launched with Expedition 8,
returned with Expedition 7)
Returned: April 29, 2004, aboard Soyuz TMA-3
Duration: 195 days

Expedition 9

Vehicle: Soyuz TMA-4
Launched: April 18, 2004, from Baikonur
Cosmodrome in Kazakhstan
Crew: ISS commander
Gennady I. Padalka
Flight engineer/science officer
E. Michael Fincke
Flight engineer André Kuipers
(launched with Expedition 9,
returned with Expedition 8)
Returned: Oct. 23, 2004, aboard Soyuz TMA-4
Duration: 188 days

Expedition 10

Vehicle: Soyuz TMA-5
Launched: Oct. 13, 2004, from Baikonur
Cosmodrome in Kazakhstan
Crew: ISS commander/science officer
Leroy Chiao
Flight engineer Salizhan S. Sharipov
Flight engineer Yuri G. Shargin
(launched with Expedition 10,
returned with Expedition 9)
Returned: April 24, 2005, aboard Soyuz TMA-5
Duration: 193 days

Expedition 11

Vehicle: Soyuz TMA-6
Launched: April 14, 2005, from Baikonur
Cosmodrome in Kazakhstan
Crew: ISS commander Sergei K. Krikalev
Flight engineer/science officer
John L. Phillips
Flight engineer Roberto Vittori
(launched with Expedition 11,
returned with Expedition 10)
Returned: Oct. 10, 2005, aboard Soyuz TMA-6
Duration: 179 days

Expedition 12

Vehicle: TMA-7
Launched: Sept. 30, 2005, from Baikonur
Cosmodrome in Kazakhstan
Crew: ISS commander/science officer
William McArthur
Flight engineer Valery Tokarev
Returned: April 8, 2005, aboard Soyuz TMA-7
Duration: 190 days

Expedition 13

Vehicle: Soyuz TMA-8
Launched: March 29, 2006, from Baikonur
Cosmodrome in Kazakhstan
Crew: ISS commander/Soyuz commander
Pavel Vinogradov
Flight engineer/science officer
Jeffrey Williams
Flight engineer Marcus Pontes
(launched with Expedition 13,
returned with Expedition 12)
Flight engineer Thomas Reiter
(launched aboard STS-121,
returned aboard STS-116)
Returned: Sept. 28, 2006, aboard Soyuz TMA-8
Duration: 183 days

Expedition 14

Vehicle: Soyuz TMA-9
Launched: Sept. 18, 2006, from Baikonur
Cosmodrome in Kazakhstan
Crew: ISS commander
Michael E. Lopez-Alegria*
**Lopez-Alegria set new U.S.
record for continuous time
in space of 215 days.*
Flight engineer Mikhail Tyurin
Flight engineer Thomas Reiter
(launched aboard STS-121,
returned aboard STS-116)
Flight engineer Sunita L. Williams
(launched aboard STS-116,
returned aboard STS-117)
Returned: April 21, 2007, aboard Soyuz TMA-9
Duration: 215 days

Expedition 15

Vehicle: Soyuz TMA-10
Launched: April 7, 2007, from Baikonur
Cosmodrome in Kazakhstan
Crew: ISS commander Fyodor N. Yurchikhin
Flight engineer Oleg V. Kotov
Flight engineer Sunita L. Williams
(launched aboard STS-116,
returned aboard STS-117)
Flight engineer Clayton C. Anderson
(launched aboard STS-117,
returned aboard STS-120)

Crew (Cont'd): Flight engineer Daniel M. Tani
(launched aboard STS-120,
returned aboard STS-122)
Returned: Oct. 21, 2007, aboard Soyuz
TMA-10
Duration: 196 days

Expedition 16

Vehicle: Soyuz TMA-11
Launched: Oct. 10, 2007, from Baikonur
Cosmodrome in Kazakhstan
Crew: ISS commander Peggy A. Whitson
Soyuz commander/flight engineer
Yuri I. Malenchenko
Flight engineer
Clayton C. Anderson
(launched aboard STS-117,
returned aboard STS-120)
Flight engineer Daniel M. Tani
(launched aboard STS-120,
returned aboard STS-122)
Flight engineer Leopold Eyharts
(launched aboard STS-122,
returned aboard STS-123)
Flight engineer Garrett E. Reisman
(launched aboard STS-123,
returned aboard STS-124)
Returned: April 19, 2008, aboard
Soyuz TMA-11
Duration: 192 days

Expedition 17

Vehicle: Soyuz TMA-12
Launched: April 8, 2008, from Baikonur
Cosmodrome in Kazakhstan
Crew: ISS commander/Soyuz commander
Sergei A. Volkov
Flight engineer Oleg D. Kononenko
Flight engineer Garrett E. Reisman
(launched aboard STS-123,
returned aboard STS-124)
Flight engineer Gregory E.
Chamitoff (launched aboard
STS-124, returned aboard STS-126)
Flight engineer Sandra H. Magnus
(launched aboard STS-126,
returned aboard STS-119)
Of Note: First mission to use all three partner
laboratories—the U.S. Destiny,
European Columbus, and the
Japanese Kibo. First mission to be
supported by four different resupply
vehicles—the space shuttle, Soyuz,
Progress, and European Automat-
ed Transfer Vehicle. First mission
to use three robotic systems—
Canadarm2, Dextre, and Kibo's
JEMRMS.

Of Note (Cont'd): First mission to be commanded by a second-generation cosmonaut; commander Sergei Volkov is the son of former cosmonaut Alexander Volkov, who served on Salyut 7 and the Mir space station.

Returned: Oct. 23, 2008, aboard Soyuz TMA-12

Duration: 199 days

Expedition 18

Vehicle: Soyuz TMA-13

Launched: Oct. 12, 2008, from Baikonur Cosmodrome in Kazakhstan

Crew: ISS commander E. Michael Fincke
Flight engineer/Soyuz commander Yuri V. Lonchakov
Flight engineer Gregory E. Chamitoff

(launched aboard STS-124, returned aboard STS-126)

Flight engineer Sandra H. Magnus (launched aboard STS-126, returned aboard STS-119)

Flight engineer Koichi Wakata (launched aboard STS-119, returned aboard STS-127)

Returned: April 8, 2009

Duration: 178 days

Expedition 19

Vehicle: Soyuz TMA-14

Launched: March 26, 2009, from Baikonur Cosmodrome in Kazakhstan

Crew: ISS commander/Soyuz commander Gennady I. Padalka

Flight engineer Michael R. Barratt
Flight engineer Koichi Wakata (launched aboard STS-119, returned aboard STS-127)

Flight engineer Timothy L. Kopra (launched aboard STS-127, returned aboard STS-128)

Of Note: The Expedition 19 crew was joined in orbit by Russian cosmonaut Roman Romanenko, ESA astronaut Frank De Winne, and CSA astronaut Robert Thirsk on May 29, 2009, launching aboard Soyuz TMA-15 from Baikonur. Their arrival inaugurated the station's first six-person crew and marked the first time that crew members from all five ISS partner agencies were living aboard at the same time.

Returned: Oct. 11, 2009

Expedition 20

Crew:	ISS commander/Soyuz commander Gennady I. Padalka (launched March 26, 2009, aboard Soyuz TMA-14; returned Oct. 11, 2009, aboard Soyuz TMA-14) Flight engineer Michael R. Barratt (launched March 26, 2009, aboard Soyuz TMA-14; returned Oct. 11, 2009, aboard Soyuz TMA-14) Flight engineer Koichi Wakata (launched aboard STS-119, returned aboard STS-127) Flight engineer Timothy L. Kopra (launched aboard STS-127, returned aboard STS-128) Flight engineer Nicole Stott (launched aboard STS-128, returned aboard STS-129) Flight engineer Frank De Winne (launched May 27, 2009, aboard Soyuz TMA-15; transitioned to Expedition 21) Flight engineer Roman Romanenko (launched May 27, 2009, aboard Soyuz TMA-15; transitioned to Expedition 21) Flight engineer Robert Thirsk (launched May 27, 2009, aboard Soyuz TMA-15; transitioned to Expedition 21)
Of Note:	Working in spacesuits inside a compartment open to vacuum, commander Gennady Padalka and flight engineer Michael Barratt conducted a 12-minute internal spacewalk on June 10, 2009, to finish rigging a port in the Zvezda command module for arrival of a new docking module in November. Because they were working in a vacuum, the activity was considered a spacewalk, the 125 th since station assembly began in 1998. This spacewalk tied the record for the shortest EVA, a mark set in 1965 by cosmonaut Alexei Leonov in the first spacewalk ever conducted.

Expedition 21

Crew: ISS commander Frank De Winne
(launched May 27, 2009, aboard Soyuz TMA-15; returned Dec. 1, 2009, aboard Soyuz TMA-15)
Soyuz commander/flight engineer Roman Romanenko
(launched May 27, 2009, aboard Soyuz TMA-15; returned Dec. 1, 2009, aboard Soyuz TMA-15)
Flight engineer Robert B. Thirsk
(launched May 27, 2009, aboard Soyuz TMA-15; returned Dec. 1, 2009, aboard Soyuz TMA-15)
Flight engineer Nicole P. Stott
(launched aboard STS-128, returned aboard STS-129)
Flight engineer Jeffrey N. Williams
(launched Sept. 30, 2009, aboard Soyuz TMA-16; transitioned to Expedition 22; returned March 18, 2010, aboard Soyuz TMA-16)
Flight engineer Maxim Suraev
(launched Sept. 30, 2009, aboard Soyuz TMA-16; transitioned to Expedition 22; returned March 18, 2010, aboard Soyuz TMA-16)

Expedition 22

Crew: ISS commander Jeffrey N. Williams
(launched Sept. 30, 2009, aboard Soyuz TMA-16; returned March 18, 2010, aboard Soyuz TMA-16)
Soyuz commander/flight engineer Maxim Suraev
(launched Sept. 30, 2009, aboard Soyuz TMA-16; returned March 18, 2010, aboard Soyuz TMA-16)
Flight engineer Oleg V. Kotov
(launched Dec. 20, 2009, aboard Soyuz TMA-17; transitioned to Expedition 23; returned June 1, 2010, aboard Soyuz TMA-17)
Flight engineer Soichi Noguchi
(launched Dec. 20, 2009, aboard Soyuz TMA-17; transitioned to Expedition 23; returned June 1, 2010, aboard Soyuz TMA-17)
Flight engineer Timothy J. Creamer
(launched Dec. 20, 2009, aboard Soyuz TMA-17; transitioned to Expedition 23; returned June 1, 2010, aboard Soyuz TMA-17)

Expedition 23

Crew: ISS commander Oleg V. Kotov (launched Dec. 20, 2009, aboard Soyuz TMA-17; returned June 1, 2010, aboard Soyuz TMA-17)
Flight engineer Soichi Noguchi (launched Dec. 20, 2009, aboard Soyuz TMA-17; returned June 1, 2010, aboard Soyuz TMA-17)
Flight engineer Timothy J. Creamer (launched Dec. 20, 2009, aboard Soyuz TMA-17; returned June 1, 2010, aboard Soyuz TMA-17)
Flight engineer Aleksandr A. Skvortsov (launched April 2, 2010, aboard Soyuz TMA-18; transitioned to Expedition 24; returned Sept. 25, 2010, aboard Soyuz TMA-18)
Flight engineer Mikhail B. Korniyenko (launched April 2, 2010, aboard Soyuz TMA-18; transitioned to Expedition 24; returned Sept. 25, 2010, aboard Soyuz TMA-18)
Flight engineer Tracy Caldwell-Dyson (launched April 2, 2010, aboard Soyuz TMA-18; transitioned to Expedition 24; returned Sept. 25, 2010, aboard Soyuz TMA-18)

Expedition 24

Crew: ISS commander Aleksandr A. Skvortsov (launched April 2, 2010, aboard Soyuz TMA-18; returned Sept. 25, 2010, aboard Soyuz TMA-18)
Flight engineer Mikhail B. Korniyenko (launched April 2, 2010, aboard Soyuz TMA-18; returned Sept. 25, 2010, aboard Soyuz TMA-18)
Flight engineer Tracy Caldwell-Dyson (launched April 2, 2010, aboard Soyuz TMA-18; returned Sept. 25, 2010, aboard Soyuz TMA-18)
Flight engineer Shannon Walker (launched June 15, 2010, aboard Soyuz TMA-19; transitioned to Expedition 25; scheduled to return November 2010)

Crew (Cont'd): Flight engineer Douglas H. Wheelock (launched June 15, 2010, aboard Soyuz TMA-19; transitioned to Expedition 25; scheduled to return November 2010)
Flight engineer Fyodor N. Yurchikhin (launched June 15, 2010, aboard Soyuz TMA-19; transitioned to Expedition 25; scheduled to return November 2010)

Expedition 25

Crew: ISS commander Douglas H. Wheelock (launched June 15, 2010, aboard Soyuz TMA-19; scheduled to return November 2010)
Flight engineer Fyodor N. Yurchikhin (launched June 15, 2010, aboard Soyuz TMA-19; scheduled to return November 2010)
Flight engineer Shannon Walker (launched June 15, 2010, aboard Soyuz TMA-19; scheduled to return November 2010)
Flight engineer Alexander Kaleri (launched Oct. 7, 2010, aboard Soyuz TMA-01M; transitioning to Expedition 26; scheduled to return March 2011)
Flight engineer Scott J. Kelly (launched Oct. 7, 2010, aboard Soyuz TMA-01M; transitioning to Expedition 26 as commander; scheduled to return March 2011)
Flight engineer Oleg Skripochka (launched Oct. 7, 2010, aboard Soyuz TMA-01M; transitioning to Expedition 26; scheduled to return March 2011)

INTERESTING ISS FACTS

The space station runs on about 7.5 million lines of software code on more than 50 computers communicating via 100 data networks transferring 400,000 signals, e.g., pressure or temperature measurements, valve positions, etc.

Astronauts, cosmonauts, and space flight participants from 15 nations have visited the International Space Station or lived aboard the station as Expedition crew members. The nations represented are the United States, Russia, Canada, Italy, France, Japan, South Africa, Belgium, Spain, the Netherlands, and Brazil.

With nine rooms, two toilets, two kitchens, and two mini-gyms, the nearly completed ISS can comfortably accommodate its six-person crew.

Astronauts eat healthy but less tasty meals because of special considerations while in space. Salt, for example, accelerates bone loss. Vitamin D must be added because of the lack of sunlight. Food is usually highly seasoned because the sense of taste diminishes during space travel. Tortillas have largely replaced bread because, in zero gravity, bread crumbs become air pollution. Products must have at least a one-year shelf life and be contained in lightweight, pressure-resistant packaging.

The ISS travels an equivalent distance to the moon and back in about a day.

In a 24-hour period, the ISS orbits Earth 16 times. As of November 2010, it has circled the Earth approximately 69,000 times and traveled approximately 1.5 billion statute miles, the equivalent of eight round-trips to the sun.

The 55-foot station robot arm is able to lift 220,000 pounds, the weight of a space shuttle orbiter.

The ISS effort involves more than 100,000 people in space agencies and at 500 contractor facilities in 37 U.S. states and in 16 countries.

NASA has begun a live video stream of astronauts working inside the ISS that includes audio of communications between Mission Control and the astronauts. Users can access the video and audio from over the Web when the ISS is in contact with the ground and during regular crew working hours. To view the streaming station video, visit:

<http://www.nasa.gov/station>

NASA has developed a video game, "Station Spacewalk," to give players the virtual opportunity to experience the thrill of working on the ISS from their computers. This game features simulations of actual EVAs conducted by NASA astronauts on missions and incorporates 3D graphics used by the agency. Players can play the game in their browser, or download it for the Windows and Mac platforms. To take a virtual spacewalk, visit:

http://www.nasa.gov/multimedia/3d_resources/station_spacewalk_game.html

**STS-1 Mission Facts — Columbia —
April 12–14, 1981**

Commander: John W. Young

Pilot: Robert Crippen

Mission Duration: 54 hours (2 days), 6 hours,
20 minutes, 32 seconds

Miles Traveled: Approximately 1,074,567 statute miles

Inclination: 40 degrees

Orbits of Earth: 36

Orbital Altitude: 145 nautical miles (166 statute miles)

Liftoff Weight: Approximately 4,457,111 pounds

Orbiter Weight at Liftoff: Approximately 219,258
pounds

Payload Weight Up and Down: Approximately
10,823 pounds

Orbiter Weight at Landing: Approximately
195,472 pounds

Landed: Runway 23 dry lake bed at Edwards Air Force
Base, Calif.

Payload: Development Flight Instrumentation and Aero-
dynamic Coefficient Identification Package

**STS-2 Mission Facts — Columbia —
Nov. 12–14, 1981**

Commander: Joe Engle

Pilot: Richard Truly

Mission Duration: 54 hours (2 days), 6 hours,
13 minutes, 13 seconds

Miles Traveled: Approximately 1,074,567 statute miles

Inclination: 38 degrees

Orbits of Earth: 36

Orbital Altitude: 137 nautical miles (157 statute miles)

Liftoff Weight: Approximately 4,470,308 pounds

Orbiter Weight at Liftoff: Approximately
230,708 pounds

Payload Weight Up and Down: Approximately
18,778 pounds

Orbiter Weight at Landing: Approximately
204,262 pounds

Landed: Runway 23 dry lake bed at Edwards Air Force
Base, Calif.

Payload: Office of Space and Terrestrial Applications
(OSTA)-1 experiments, Orbiter Experiments (OEX)

**STS-3 Mission Facts — Columbia —
March 22–30, 1982**

Commander: Jack Lousma

Pilot: Gordon Fullerton

Mission Duration: 192 hours (8 days), 4 minutes,
45 seconds

STS-3 Mission Facts (Cont)

Miles Traveled: Approximately 4.4 million miles

Inclination: 38 degrees

Orbits of Earth: 129

Orbital Altitude: 128 nautical miles (147 statute miles)

Liftoff Weight: Approximately 4,468,755 pounds

Orbiter Weight at Liftoff: Approximately
235,415 pounds

Payload Weight Up and Down: Approximately
22,710 pounds

Orbiter Weight at Landing: Approximately
207,072 pounds

Landed: Runway 17 dry lake bed at White Sands Missile Range, New Mexico

Payload: Office of Space Science (OSS) experiments, Monodisperse Latex Reactor (MLR), Electrophoresis Verification Test (EEVT), Plant Lignification Experiment

STS-4 Mission Facts — Columbia — June 27–July 4, 1982

Commander: Thomas K. Mattingly II

Pilot: Henry Hartsfield

Mission Duration: 168 hours (7 days), 1 hour, 9 minutes,
40 seconds

Miles Traveled: Approximately 3.3 million statute miles

Inclination: 28.45 degrees

Orbits of Earth: 112

Orbital Altitude: 160 nautical miles (184 statute miles)

Liftoff Weight: Approximately 4,481,935 pounds

Orbiter Weight at Liftoff: Approximately
241,664 pounds

Payload Weight Up and Down: Approximately
24,492 pounds

Orbiter Weight at Landing: Approximately
208,946 pounds

Landed: Concrete runway 22 at Edwards Air Force Base, Calif.

Payload: Induced Environment Contamination Monitor (IECM); Monodisperse Latex Reactor (MLR); Continuous Flow Electrophoresis System (CFES); Development Flight Instrumentation (DFI); Orbiter Experiments (OEX); first NASA getaway special (GAS); Night/Day Optical Survey of Lightning (NOSL) experiment; Vapor Phase Compression (VPC) freezer heat exchanger dynamics for freezing samples; Aerodynamic Coefficient Identification Package (ACIP) experiment

**STS-5 Mission Facts — Columbia —
Nov. 11–16, 1982**

Commander: Vance D. Brand

Pilot: Robert F. Overmyer

Mission Specialist: Joseph P. Allen

Mission Specialist: William B. Lenoir

Mission Duration: 120 hours (5 days), 2 hours,
14 minutes, 26 seconds

Miles Traveled: 2,110,849 statute miles

Inclination: 28.45 degrees

Orbits of Earth: 81

Orbital Altitude: 160 nautical miles (184 statute miles)

Liftoff Weight: Approximately 4,487,268 pounds

Orbiter Weight at Liftoff: Approximately 247,113 pounds

Payload Weight Up: Approximately 32,080 pounds

Payload Weight Down: Approximately 17,495 pounds

Orbiter Weight at Landing: 202,480 pounds

Landed: Concrete runway 22 at Edwards Air Force
Base, Calif.

Payload: First mission to deploy commercial commu-
nications satellites: Satellite Business Systems
(SBS)-C with Payload Assist Module (PAM)-D;
Telesat-E (Canadian communications satellite)
with PAM-D. Monodisperse Latex Reactor (MLR);
Continuous Flow Electrophoresis System (CFES);
three getaway specials (GAS); student experi-
ments; GLOW experiment; Vestibular experiment,
Oxygen Interaction With Materials experiment

**STS-6 Mission Facts — Challenger —
April 4–9, 1983**

Commander: Paul Weitz

Pilot: Karol Bobko

Mission Specialist: Donald Peterson

Mission Specialist: Story Musgrave

Mission Duration: 120 hours (5 days), 23 minutes,
42 seconds

Miles Traveled: 2,094,293 statute miles

Inclination: 28.45 degrees

Orbits of Earth: 80

Orbital Altitude: 155 nautical miles (178 statute miles)

Liftoff Weight: Approximately 4,487,255 pounds

Orbiter Weight at Liftoff: Approximately
256,744 pounds

Payload Weight Up: Approximately 46,971 pounds

Payload Weight Down: Approximately 9,425 pounds

Orbiter Weight at Landing: Approximately
190,330 pounds

Landed: Concrete runway 22 at Edwards Air Force
Base, Calif.

STS-6 Mission Facts (Cont)

Payload: Deployment of Tracking and Data Relay Satellite (TDRS)-A with Inertial Upper Stage (IUS)-2; Continuous Flow Electrophoresis System (CFES); Monodisperse Latex Reactor (MLR); Night/Day Optical Survey of Lightning (NOSL) experiment; three getaway specials (GAS)

Extravehicular Activity (EVA) conducted by Story Musgrave and Donald Peterson, 3 hours and 54 minutes.

STS-7 Mission Facts — Challenger — June 18–24, 1983

Commander: Robert L. Crippen

Pilot: Frederick H. Hauck

Mission Specialist: Sally K. Ride

Mission Specialist: John M. Fabian

Mission Specialist: Norman E. Thagard

Mission Duration: 144 hours (6 days), 2 hours, 23 minutes, 59 seconds

Miles Traveled: 2,530,567 statute miles

Inclination: 28.45 degrees

Orbits of Earth: 97

Orbital Altitude: 160 nautical miles (184 statute miles)

Liftoff Weight: Approximately 4,482,241 pounds

Orbiter Weight at Liftoff: Approximately 249,178 pounds

Payload Weight Up: Approximately 37,124 pounds

Payload Weight Down: Approximately 22,175 pounds

Orbiter Weight at Landing: Approximately 204,043 pounds

Landed: Runway 15 dry lake bed at Edwards Air Force Base, Calif.

Payload: Office of Space and Terrestrial Applications (OSTA)-2 experiments; deployment of PALAPA-B1 communications satellite for Indonesia with Payload Assist Module (PAM)-D and Telesat-F communications satellite for Canada with PAM-D; German Shuttle Pallet Satellite (SPAS)-01; seven getaway specials (GAS); Monodisperse Latex Reactor (MLR); Continuous Flow Electrophoresis System (CFES)

STS-8 Mission Facts — Challenger — Aug. 30–Sept. 5, 1983

Commander: Richard H. Truly

Pilot: Daniel C. Brandenstein

Mission Specialist: Guion S. Bluford Jr.

Mission Specialist: Dale A. Gardner

Mission Specialist: William E. Thornton

Mission Duration: 144 hours (6 days), 1 hour, 8 minutes, 43 seconds

STS-8 Mission Facts (Cont)

Miles Traveled: 2,514,478 statute miles

Inclination: 28.45 degrees

Orbits of Earth: 97

Orbital Altitude: 160 nautical miles (184 statute miles)

Liftoff Weight: Approximately 4,492,074 pounds

Orbiter Weight at Liftoff: Approximately 242,742 pounds

Payload Weight Up: Approximately 30,076 pounds

Payload Weight Down: Approximately 22,631 pounds

Orbiter Weight at Landing: Approximately 203,945 pounds

Landed: Concrete runway 22 at Edwards Air Force Base, Calif.

Payload: Deployment of INSAT (India communication satellite) with Payload Assist Module (PAM)-D, Payload Flight Test Article (PFTA)/Payload Deployment Retrieval System (PDRS), Continuous Flow Electrophoresis (CFES), biomedical experiments. 250,000 express mail envelopes with special cachet for U.S. Postal Service were carried for a first-day cover.

Of Note: First night launch and night landing

STS-9 Mission Facts — Columbia — Nov. 28–Dec. 8, 1983

Commander: John Young

Pilot: Brewster Shaw

Mission Specialist: Robert Parker

Mission Specialist: Owen Garriott

Payload Specialist: Byron Lichtenberg

Payload Specialist: Ulf Merbold

Mission Duration: 240 hours (10 days), 7 hours, 47 minutes, 24 seconds

Miles Traveled: 4,295,853 statute miles

Inclination: 57 degrees

Orbits of Earth: 166

Orbital Altitude: 135 nautical miles (155 statute miles)

Liftoff Weight: Approximately 4,503,361 pounds

Orbiter Weight at Liftoff: Approximately 247,619 pounds

Payload Weight Up and Down: Approximately 33,264 pounds

Orbiter Weight at Landing: Approximately 220,027 pounds

Landed: Runway 17 dry lake bed at Edwards Air Force Base, Calif.

Payload: Habitable Spacelab-1 and pallet carried 71 experiments. The six-man crew was divided into two 12-hour-day red and blue teams to operate experiments. First high-inclination orbit of 57 degrees

**41-B Mission Facts — Challenger —
Feb. 3–11, 1984**

Commander: Vance Brand

Pilot: Robert Gibson

Mission Specialist: Bruce McCandless

Mission Specialist: Robert Stewart

Mission Specialist: Ronald McNair

Mission Duration: 168 hours (7 days), 23 hours,
15 minutes, 55 seconds

Miles Traveled: Approximately 3,311,379 statute miles

Inclination: 28.45 degrees

Orbits of Earth: 127

Orbital Altitude: 165 nautical miles (189 statute miles)

Liftoff Weight: Approximately 4,498,443 pounds

Orbiter Weight at Liftoff: Approximately
250,285 pounds

Payload Weight Up: Approximately 33,868 pounds

Payload Weight Down: Approximately 19,005 pounds

Orbiter Weight at Landing: Approximately
201,238 pounds

Landed: Runway 15 at Kennedy Space Center, Fla.

Payload: PALAPA-B2 (Indonesian communications satellite) with Payload Assist Module (PAM)-D and WESTAR (Western Union communications satellite)-VI with PAM-D deployment. Both satellites were deployed but the PAM-D in each satellite failed to ignite, leaving both satellites in Earth orbit. Both satellites were retrieved and returned to Earth for renovation on the STS-51-A mission. The manned maneuvering unit (MMU) was tested with extravehicular astronauts as free-flyers without tethers as far as 320 feet from the orbiter. Shuttle Pallet Satellite (SPAS)-01 experiments; Monodisperse Latex Reactor (MLR); Isoelectric Focusing Experiment (IEF); Acoustic Containerless Experiment System (ACES); Cinema 360 cameras; five getaway specials (GAS); Aerodynamic Coefficient Identification (ACIP)/High Resolution Accelerometer Package (HIRAP)

Extravehicular Activity (EVA) conducted by Bruce McCandless and Robert Stewart during two spacewalks for a total of 11 hours, 37 minutes. EVA 1, 5 hours, 35 minutes; EVA 2, 6 hours, 2 minutes. First flight of the manned maneuvering unit (MMU). McCandless operating time 1 hour, 55 minutes; Stewart, 44 minutes.

**41-C Mission Facts (STS-13) — Challenger —
April 6–13, 1984**

Commander: Robert Crippen

Pilot: Francis (Dick) Scobee

Mission Specialist: Terry Hart

Mission Specialist: James van Hoften

STS-41-C Mission Facts (Cont)

Mission Specialist: George Nelson

Mission Duration: 144 hours (6 days), 23 hours, 40 minutes, 7 seconds

Miles Traveled: 2.87 million statute miles

Inclination: 28.45 degrees

Orbits of Earth: 107

Orbital Altitude: Approximately 272 nautical miles (313 statute miles)

Liftoff Weight: Approximately 4,508,234 pounds

Orbiter Weight at Liftoff: Approximately 254,329 pounds

Payload Weight Up: Approximately 38,266 pounds

Payload Weight Down: Approximately 16,870 pounds

Orbiter Weight at Landing: Approximately 196,975 pounds

Landed: Runway 17 dry lake bed at Edwards Air Force Base, Calif.

Payload: Solar Maximum Mission (SMM) repair, manned maneuvering unit (MMU) satellite support, deployment of Long-Duration Exposure Facility (LDEF) in earth orbit free drift. LDEF contained 57 experiments and weighed about 22,000 pounds. Cinema 360 and IMAX 70-mm cameras.

Extravehicular Activity (EVA) conducted by James van Hoften and George Nelson during two spacewalks for a total of 10 hours, 6 minutes. EVA 1, 2 hours, 59 minutes; EVA 2, 7 hours, 7 minutes. Manned maneuvering unit (MMU) operating time, Nelson 42 minutes, van Hoften 28 minutes.

Of Note: First repair on orbit of a satellite, Solar Maximum Mission, by van Hoften and Nelson

41-D Mission Facts (STS-14) — Discovery — Aug. 30–Sept. 5, 1984

Commander: Henry Hartsfield Jr.

Pilot: Michael Coats

Mission Specialist: Richard Mullane

Mission Specialist: Steven Hawley

Mission Specialist: Judith Resnik

Payload Specialist: Charles Walker (as industrial payload specialist representing McDonnell Douglas Corp.)

Mission Duration: 144 hours (6 days), 56 minutes, 4 seconds

Miles Traveled: 2.49 million statute miles

Inclination: 28.45 degrees

Orbits of Earth: 96

Orbital Altitude: 160 nautical miles (184 statute miles)

Liftoff Weight: Approximately 4,517,534 pounds

Orbiter Weight at Liftoff: Approximately 263,477 pounds

STS-41-D Mission Facts (STS-14) (Cont)

Payload Weight Up: Approximately 47,516 pounds

Payload Weight Down: Approximately 11,296 pounds

Orbiter Weight at Landing: Approximately 201,674 pounds

Landed: Runway 17 dry lake bed at Edwards Air Force Base, Calif.

Payload: Satellite Business System (SBS)-D communications satellite with Payload Assist Module (PAM)-D deployment; Syncom IV-2 communications satellite with its unique stage deployment; Telstar (American Telephone and Telegraph) 3-C with PAM-D deployment; Office of Aeronautics and Space Technology (OAST)-1 experiments; deployment and restowing of large solar array; Continuous Flow Electrophoresis (CFES); IMAX camera. A student experiment, sponsored by Rockwell International, of indium crystal growth using the float zone technique was successful, although a blown fuse resulted in a premature shutdown.

41-G Mission Facts (STS-17) — Challenger — Oct. 5–13, 1984

Commander: Robert Crippen

Pilot: Jon McBride

Mission Specialist: David Leestma

Mission Specialist: Sally Ride

Mission Specialist: Kathryn Sullivan

Payload Specialist: Paul Scully-Power

Payload Specialist: Marc Garneau

Mission Duration: 192 hours (8 days), 5 hours, 23 minutes, 33 seconds

Miles Traveled: 3,434,444 statute miles

Inclination: 57 degrees

Orbits of Earth: 132

Orbital Altitude: 190 nautical miles (218 statute miles)

Liftoff Weight: Approximately 4,493,317 pounds

Orbiter Weight at Liftoff: Approximately 242,790 pounds

Payload Weight Up: Approximately 23,465 pounds

Payload Weight Down: Approximately 18,516 pounds

Orbiter Weight at Landing: Approximately 202,266 pounds

Landed: Runway 33 at Kennedy Space Center, Fla.

Payload: Earth Radiation Budget Satellite (ERBS) deployment; Office of Space and Terrestrial Applications (OSTA)-3 experiments; Large Format Camera (LFC); IMAX camera

Extravehicular Activity (EVA) conducted by Kathryn Sullivan and David Leestma, 3 hours, 29 minutes.

Of Note: First use of Orbital Refueling System (ORS) with extravehicular activity (EVA) astronauts

**51-A Mission Facts — Discovery —
Nov. 8–16, 1984**

Commander: Frederick Hauck

Pilot: David Walker

Mission Specialist: Joseph Allen

Mission Specialist: Anna Fisher

Mission Specialist: Dale Gardner

Mission Duration: 168 hours (7 days), 23 hours,
44 minutes, 56 seconds

Miles Traveled: 3,289,406 statute miles

Inclination: 28.5 degrees

Orbits of Earth: 126

Orbital Altitude: 161 nautical miles (185 statute miles)

Liftoff Weight: Approximately 4,519,901 pounds

Orbiter Weight at Liftoff: Approximately
263,324 pounds

Payload Weight Up: Approximately 45,306 pounds

Payload Weight Down: Approximately 24,853 pounds

Orbiter Weight at Landing: Approximately
207,505 pounds

Landed: Runway 15 at Kennedy Space Center, Fla.

Payload: Telesat (Canada communications satellite)-H with Payload Assist Module (PAM)-D deployment, Syncom IV-1 communications satellite deployment with its unique stage; retrieval of PALAPA B-2 and WESTAR VI communications satellites with PAM-D that failed to ignite on the STS-41-B mission. Manned maneuvering unit (MMU) used for retrieval. Diffusive Mixing of Organic Solutions (DMOS) experiment

Extravehicular Activity (EVA) conducted by Joseph Allen and Dale Gardner during two spacewalks for a total of 12 hours, 14 minutes. EVA 1, 6 hours, 13 minutes; EVA 2, 6 hours and 1 minute. Manned maneuvering unit (MMU) operating time Allen 2 hours, 22 minutes, Gardner 1 hour, 40 minutes.

Of Note: First retrieval of two satellites (PALAPA B-2 and WESTAR VI) for return to Earth

**51-C Mission Facts — Discovery —
Jan. 24–27, 1985**

Commander: Thomas K. Mattingly II

Pilot: Loren J. Shriver

Mission Specialist: Ellison S. Onizuka

Mission Specialist: James F. Buchli

Payload Specialist: Gary E. Payton

Mission Duration: 72 hours (3 days), 1 hour, 33 minutes,
23 seconds

Inclination: 28.45 degrees

Orbits of Earth: 48

Landed: Runway 15 at Kennedy Space Center, Fla.

Payload: DOD

**51-D Mission Facts — Discovery —
April 12–19, 1985**

Commander: Karol J. Bobko

Pilot: Donald E. Williams

Mission Specialist: Jeffrey A. Hoffman

Mission Specialist: S. David Griggs

Mission Specialist: Margaret Rhea Seddon

Payload Specialist: Charles D. Walker (as industrial payload specialist representing McDonnell Douglas Corp.)

Payload Specialist: Senator Jake Garn (Utah)

Mission Duration: 144 hours (6 days), 23 hours, 55 minutes, 23 seconds

Miles Traveled: 2,889,785 statute miles

Inclination: 28.45 degrees

Orbits of Earth: 109

Orbital Altitude: 248 nautical miles (285 statute miles)

Liftoff Weight: Approximately 4,505,245 pounds

Orbiter Weight at Liftoff: Approximately 250,891 pounds

Payload Weight Up: Approximately 35,824 pounds

Payload Weight Down: Approximately 13,248 pounds

Orbiter Weight at Landing: Approximately 198,014 pounds

Landed: Runway 33 at Kennedy Space Center, Fla.

Payload: Telesat (Canada communications satellite)-I with Payload Assist Module (PAM)-D deployment; Syncom IV-3 communications satellite deployment with its unique stage (unique stage failed to ignite); Continuous Flow Electrophoresis (CFES); Phase Partitioning Experiment (PPE); student experiments, two getaway specials (GAS); informal science studies (Toys in Space)

Extravehicular activity (EVA) conducted by Jeffrey Hoffman and David Griggs, 3 hours, 10 minutes.

**51-B Mission Facts — Challenger —
April 29–May 6, 1985**

Commander: Robert F. Overmyer

Pilot: Frederick D. Gregory

Mission Specialist: Don Leslie Lind

Mission Specialist: Norman E. Thagard

Mission Specialist: William E. Thornton

Payload Specialist: Taylor E. Wang

Payload Specialist: Lodewijk van den Berg

Mission Duration: 168 hours (7 days), 8 minutes, 46 seconds

Miles Traveled: Approximately 2,890,383 statute miles

Inclination: 57 degrees

Orbits of Earth: 110

Orbital Altitude: 193 nautical miles (222 statute miles)

51-B Mission Facts (Cont)

Liftoff Weight: Approximately 4,512,009 pounds

Payload Weight Up: Approximately 31,407 pounds

Payload Weight Down: Approximately 31,302 pounds

Orbiter Weight at Landing: Approximately
212,465 pounds

Landed: Runway 17 dry lake bed at Edwards Air Force Base, Calif.

Payload: Spacelab-3 experiments in habitable Spacelab and mission peculiar experiment support structure. The experiments represented a total of five different disciplines: materials processing in space, environmental observations, life science, astrophysics, and technology experiments; two getaway specials (GAS). The flight crew was split into gold and silver shifts working 12-hour days during the flight.

51-G Mission Facts — Discovery — June 17–24, 1985

Commander: Daniel Brandenstein

Pilot: John Creighton

Mission Specialist: John Fabian

Mission Specialist: Steven Nagel

Mission Specialist: Shannon Lucid

Payload Specialist: Patrick Baudry

Payload Specialist: Sultan Salman Abdul Azziz Al Sa'ud

Mission Duration: 168 hours (7 days), 1 hour, 38 minutes, 52 seconds

Miles Traveled: Approximately 2,916,127 statute miles

Inclination: 28.45 degrees

Orbits of Earth: 111

Orbital Altitude: 190 nautical miles (218 statute miles)

Orbiter Weight at Liftoff: Approximately
256,421 pounds

Liftoff Weight: Approximately 4,516,613 pounds

Payload Weight Up: Approximately 44,477 pounds

Payload Weight Down: Approximately 21,645 pounds

Orbiter Weight at Landing: Approximately
204,169 pounds

Landed: Runway 23 dry lake bed at Edwards Air Force Base, Calif.

Payload: Deployment of Morelos (Mexico communications satellite)-A with Payload Assist Module (PAM)-D; Arabsat (Arab League communications satellite)-1B with PAM-D; and Telstar (American Telephone and Telegraph communications satellite) with PAM-D; Shuttle Pointed Autonomous Research Tool for Astronomy (SPARTAN)-1; Automated Directional Solidification Furnace (ADSF); High-Precision Tracking Experiment (HPTE); Orbiter Experiments (OEX); French Echocardiograph Experiment (FEE) and French Pocket Experiment (FPE)

**51-F Mission Facts — Challenger —
July 29–Aug. 6, 1985**

Commander: Gordon Fullerton

Pilot: Roy Bridges

Mission Specialist: Story Musgrave

Mission Specialist: Anthony England

Mission Specialist: Karl Henize

Payload Specialist: Loren Acton

Payload Specialist: John-David Bartoe

Mission Duration: 168 hours (7 days), 22 hours,
45 minutes, 26 seconds

Miles Traveled: Approximately 3,283,543 statute miles

Inclination: 49.5 degrees

Orbits of Earth: 126

Orbital Altitude: 143 nautical miles (164 statute miles)

Orbiter Weight at Liftoff: Approximately 252,628 pounds

Liftoff Weight: Approximately 4,515,554 pounds

Payload Weight Up and Down: Approximately
34,400 pounds

Orbiter Weight at Landing: Approximately
216,735 pounds

Landed: Runway 23 dry lake bed at Edwards Air Force
Base, Calif.

Payload: Spacelab-2 with 13 experiments; Shuttle
Amateur Radio Experiment (SAREX); Protein Crystal
Growth (PCG).

Of Note: Three minutes, 31 seconds into the ascent,
one of two high-pressure fuel turbopump turbine
discharge temperature sensors for the center engine
failed. Two minutes, 12 seconds later, the second
sensor failed, causing shutdown of the center
engine. The failed SSME resulted in an Abort to Orbit
trajectory, where the shuttle achieves a lower than
planned orbital altitude. Because the primary mis-
sion objective was to verify performance of Spacelab
systems, the mission was still declared successful.

**51-I Mission Facts — Discovery —
Aug. 27–Sept. 3, 1985**

Commander: Joe H. Engle

Pilot: Richard O. Covey

Mission Specialist: James van Hoften

Mission Specialist: William F. Fisher

Mission Specialist: John M. Lounge

Mission Duration: 168 hours (7 days), 2 hours,
17 minutes, 42 seconds

Miles Traveled: 2,919,576 statute miles

Inclination: 28.45 degrees

Orbits of Earth: 111

Orbital Altitude: 190 nautical miles (218 statute miles)

Liftoff Weight: Approximately 4,512,130 pounds

Orbiter Weight at Liftoff: Approximately
262,309 pounds

51-I Mission Facts (Cont)

Orbiter Weight at Landing: Approximately 196,674 pounds

Payload Weight Up: Approximately 43,988 pounds

Payload Weight Down: Approximately 13,452 pounds

Landed: Runway 23 dry lake bed at Edwards Air Force Base, Calif.

Payload: Deploy ASC (American Satellite Company)-1 with Payload Assist Module (PAM)-D; deploy AUSSAT (Australian communications satellite)-1 with PAM-D; deploy Syncom IV-4 communications satellite with its unique stage; retrieve Leasat-3 communications satellite, repair and deploy by extra-vehicular activity (EVA) astronauts; Physical Vapor Transport Organic Solids (PVTOS) experiment

Extravehicular Activity (EVA) conducted by James van Hoften and William Fisher during two spacewalks for a total of 11 hours, 46 minutes. EVA 1, 7 hours, 20 minutes; EVA 2, 4 hours, 26 minutes.

51-J Mission Facts — Atlantis — Oct. 3–7, 1985

Commander: Karol J. Bobko

Pilot: Ronald J. Grabe

Mission Specialist: David C. Hilmers

Mission Specialist: Robert L. Stewart

Payload Specialist: Major William A. Pailles

Mission Duration: 96 hours (4 days), 1 hour, 44 minutes, 38 seconds

Inclination: 28.5 degrees

Orbital Altitude: 278 nautical miles (319 statute miles)

Orbits of Earth: 63

Landed: Runway 23 dry lake bed at Edwards Air Force Base, Calif.

Payload: DOD

61-A Mission Facts — Challenger — Oct. 30–Nov. 6, 1985

Commander: Henry W. Hartsfield Jr.

Pilot: Steven R. Nagel

Mission Specialist: James F. Buchli

Mission Specialist: Guion S. Bluford Jr.

Mission Specialist: Bonnie J. Dunbar

Payload Specialist: Reinhard Furrer, West Germany

Payload Specialist: Wubbo Ockels, Netherlands

Payload Specialist: Ernst Messerschmid, West Germany

Mission Duration: 168 hours (7 days), 44 minutes, 51 seconds

Miles Traveled: Approximately 2,909,352 statute miles

Inclination: 57 degrees

61-A Mission Facts (Cont)

Orbits of Earth: 111

Orbital Altitude: 180 nautical miles (207 statute miles)

Liftoff Weight: Approximately 4,508,496 pounds

Payload Weight Up: Approximately 31,861 pounds

Payload Weight Down: Approximately 31,711 pounds

Orbiter Weight at Liftoff: Approximately 243,762 pounds

Orbiter Weight at Landing: Approximately
214,171 pounds

Landed: Runway 17 dry lake bed at Edwards Air Force Base, Calif.

Payload: Spacelab D-1 with habitable module and 76 experiments. Six of the eight crew members were divided into a blue and red team working 12-hour shifts for 24-hour-a-day operation. The remaining two crew members were "switch hitters."

Of Note: This fourth Spacelab mission was the first shuttle flight to be largely financed and conducted by another nation, West Germany.

61-B Mission Facts — Atlantis — Nov. 26–Dec. 3, 1985

Commander: Brewster A. Shaw

Pilot: Bryan D. O'Conner

Mission Specialist: Sherwood C. Spring

Mission Specialist: Mary L. Cleave

Mission Specialist: Jerry L. Ross

Payload Specialist: Charles D. Walker (as industrial payload specialist representing McDonnell Douglas Corp.)

Payload Specialist: Rodolfo Neri Vela (Mexico)

Mission Duration: 144 hours (6 days), 21 hours,
4 minutes, 49 seconds

Miles Traveled: Approximately 2,838,972 statute miles

Inclination: 28.45 degrees

Orbits of Earth: 108

Orbital Altitude: 190 nautical miles (218 statute miles)

Liftoff Weight: Approximately 4,514,530 pounds

Orbiter Weight at Liftoff: Approximately 261,610 pounds

Payload Weight Up: Approximately 48,041 pounds

Payload Weight Down: Approximately 20,464 pounds

Orbiter Weight at Landing: Approximately
205,732 pounds

Landed: Concrete runway 22 at Edwards Air Force Base, Calif.

Payload: Deploy SATCOM (RCA-Satellite Communications) Ku-2 with Payload Assist Module (PAM)-D II; deploy Morelos (Mexico communications satellite)-B with PAM-D; deploy AUSSAT (Australian communications satellite)-2 with PAM-D; EASE/ACCESS (Assembly of Structures—Assembly Concept for Construction of Erectable Space Structures) by extravehicular activity (EVA)

61-B Mission Facts (Cont)

astronauts; Continuous Flow Electrophoresis System (CFES); Diffusive Mixing of Organic Solutions (DMOS); IMAX camera; one getaway special (GAS); Linhof camera and Hasseblad camera

Extravehicular Activity (EVA) conducted by Jerry Ross and Sherwood Spring during two spacewalks for a total of 12 hours, 20 minutes. EVA 1, 5 hours, 34 minutes; EVA 2, 6 hours, 46 minutes.

61-C Mission Facts — Columbia — Jan. 12–18, 1986

Commander: Robert L. Gibson

Pilot: Charles F. Bolden Jr.

Mission Specialist: George D. Nelson

Mission Specialist: Steven A. Hawley

Mission Specialist: Franklin R. Chang-Diaz

Payload Specialist: Robert J. Cenker

Payload Specialist: Rep. Bill Nelson

Mission Duration: 144 hours (6 days), 2 hours, 3 minutes, 51 seconds

Miles Traveled: Approximately 2,528,658 statute miles

Inclination: 28.45 degrees

Orbits of Earth: 97

Orbital Altitude: 185 nautical miles (212 statute miles)

Liftoff Weight: Approximately 4,509,360 pounds

Orbiter Weight at Liftoff: Approximately 256,003 pounds

Payload Weight Up: Approximately 32,462 pounds

Payload Weight Down: Approximately 20,111 pounds

Orbiter Weight at Landing: Approximately 210,161 pounds

Landed: Concrete runway 22 at Edwards Air Force Base, Calif.

Payload: Deployed SATCOM (RCA-Satellite Communications) Ku-1 with Payload Assist Module (PAM)-D II; Materials Science Laboratory; Comet Halley Active Monitoring Experiment (CHAMP); Hitchhiker (HH)—Goddard (G)-1; thirteen getaway specials (GAS); student experiment; Initial Blood Storage Equipment (IBSE); Characterization of Space Motion Sickness (SMS)

51-L Mission Facts — Challenger — Jan. 28, 1986

Commander: Francis R. Scobee

Pilot: Michael J. Smith

Mission Specialist: Ellison S. Onizuka

Mission Specialist: Judith A. Resnik

Mission Specialist: Ronald E. McNair

Payload Specialist: Gregory Jarvis (Hughes)

51-L Mission Facts (Cont)

Payload Specialist: Sharon Christa McAuliffe, Teacher In Space

Inclination: 28.45 degrees

Liftoff Weight: Approximately 4,526,583 pounds

Orbiter Weight at Liftoff: Approximately 268,829 pounds

Payload Weight Up: Approximately 52,308 pounds

Payload: Tracking Data Relay Satellite (TDRS)-B; SPARTAN-203 Halley's Comet Experiment; Teacher in Space Project; Fluid Dynamics Experiment; Comet Halley Active Monitoring Program; Phase Partitioning Experiment (PPE); Radiation Monitoring Experiment (RME); three Shuttle Student Involvement Program experiments

Loss of vehicle and crew during launch, 11:39 a.m. EST

STS-26 Mission Facts — Discovery — Sept. 29–Oct. 3, 1988

Commander: Frederick H. Hauck

Pilot: Richard O. Covey

Mission Specialist: John M. Lounge

Mission Specialist: George D. Nelson

Mission Specialist: David C. Hilmers

Mission Duration: 96 hours (4 days), 1 hour, 11 seconds

Miles Traveled: Approximately 1.68 million statute miles

Inclination: 28.5 degrees

Orbits of Earth: 63

Orbital Altitude: 163 nautical miles (187 statute miles)

Liftoff Weight: Approximately 4,522,411 pounds

Orbiter Weight at Liftoff: Approximately 254,606 pounds

Payload Weight Up: Approximately 46,478 pounds

Payload Weight Down: Approximately 8,964 pounds

Orbiter Weight at Landing: Approximately 194,184 pounds

Landed: Runway 17 dry lake bed at Edwards Air Force Base, Calif.

Payload: Deploy IUS (Inertial Upper Stage) with Tracking and Data Relay Satellite (TDRS)-CT; 3M's Physical Vapor Transport Organics Solids 2 experiment (PVTOS); Automated Directional Solidification Furnace (ADSF); Infrared Communications Flight Experiment (IRCFE); Protein Crystal Growth II (PCG); Isoelectric Focusing (ISF)-2; Phase Partitioning Experiment (PPE); Aggregation of Red Blood Cells (ARC)-2; Mesoscale Lightning Experiment (MLE)-1; Earth Limb Radiance (ELRAD); Orbiter Experiments (OEX); Autonomous Supporting Instrumentation System (OASIS)-I; two Shuttle Student Involvement Project (SSIP) experiments

**STS-27 Mission Facts — Atlantis —
Dec. 2–6, 1988**

Commander: Robert L. Gibson

Pilot: Guy S. Gardner

Mission Specialist: Richard M. Mullane

Mission Specialist: Jerry L. Ross

Mission Specialist: William M. Shepherd

Mission Duration: 96 hours (4 days), 9 hours, 5 minutes,
35 seconds

Orbits of Earth: 68

Inclination: 57 degrees

Landed: Runway 17 dry lake bed at Edwards Air Force
Base, Calif.

Payload: DOD

**STS-29 Mission Facts — Discovery —
March 13–18, 1989**

Commander: Michael L. Coats

Pilot: John E. Blaha

Mission Specialist: James F. Buchli

Mission Specialist: Robert C. Springer

Mission Specialist: James P. Bagian

Mission Duration: 96 hours (4 days), 23 hours, 38 min-
utes, 52 seconds

Miles Traveled: Approximately 2 million statute miles

Inclination: 28.45 degrees

Orbits of Earth: 79

Orbital Altitude: 160 nautical miles (184 statute miles)

Liftoff Weight: Approximately 4,524,261 pounds

Orbiter Weight at Liftoff: Approximately 256,357
pounds

Payload Weight Up: Approximately 38,097 pounds

Payload Weight Down: Approximately 9,861 pounds

Orbiter Weight at Landing: Approximately 194,789
pounds

Landed: Concrete runway 22 at Edwards AFB, Calif.

Payload: Deploy IUS (Inertial Upper Stage) with Tracking
and Data Relay Satellite (TDRS)-D; Protein Crystal
Growth (PCG); Chromosome and Plant Cell Divi-
sion in Space; IMAX 70mm camera; Shuttle Student
Involvement Project (SSIP) experiments: SSIP 82-8,
Effects of Weightlessness in Space Flight on the
Healing of Bone Fractures, and SSIP 83-9, Chicken
Embryo Development in Space; Air Force Maui
Optical Site (AMOS) experiment

**STS-30 Mission Facts — Atlantis —
May 4–8, 1989**

Commander: David M. Walker

Pilot: Ronald J. Grabe

Mission Specialist: Norman E. Thagard

STS-30 Mission Facts (Cont)

Mission Specialist: Mary L. Cleave

Mission Specialist: Mark C. Lee

Mission Duration: 96 hours (4 days), 57 minutes,
31 seconds

Miles Traveled: 1,681,997 statute miles

Inclination: 28.85 degrees

Orbits of Earth: 64

Orbital Altitude: 160 nautical miles (184 statute miles)

Liftoff Weight: Approximately 4,527,426 pounds

Orbiter Weight at Liftoff: Approximately 261,118 pounds

Payload Weight Up: Approximately 45,930 pounds

Payload Weight Down: Approximately 7,701 pounds

Orbiter Weight at Landing: Approximately
192,459 pounds

Landed: Concrete runway 22 at Edwards AFB, Calif.

Payload: Deploy IUS with Magellan spacecraft; Fluids
Experiment Apparatus (FEA); Mesoscale Lightning
Experiment (MLE); Air Force Maui Optical Site
(AMOS) experiment

STS-28 Mission Facts — Columbia — Aug. 8–13, 1989

Commander: Brewster H. Shaw

Pilot: Richard N. Richards

Mission Specialist: David C. Leestma

Mission Specialist: James C. Adamson

Mission Specialist: Mark N. Brown

Mission Duration: 120 hours (5 days), 1 hour,
9 seconds

Inclination: 57 degrees

Landed: Runway 17 dry lake bed at Edwards Air Force
Base, Calif.

Payload: DOD

STS-34 Mission Facts — Atlantis — Oct. 18–23, 1989

Commander: Donald E. Williams

Pilot: Michael J. McCulley

Mission Specialist: Shannon W. Lucid

Mission Specialist: Ellen S. Baker

Mission Specialist: Franklin R. Chang-Diaz

Mission Duration: 96 hours (4 days), 23 hours,
39 minutes, 24 seconds

Miles Traveled: 2 million statute miles

Inclination: 34.30 degrees; first flight at this inclination

Orbits of Earth: 79

Orbital Altitude: 161 nautical miles (185 statute miles)

Liftoff Weight: Approximately 4,524,224 pounds

Orbiter Weight at Liftoff: Approximately
257,569 pounds

STS-34 Mission Facts (Cont)

Payload Weight Up: Approximately 48,643 pounds

Payload Weight Down: Approximately 10,625 pounds

Orbiter Weight at Landing: Approximately 195,954 pounds

Landed: Runway 23 dry lake bed at Edwards Air Force Base, Calif.

Payload: Deploy IUS with Galileo spacecraft; Shuttle Solar Backscatter Ultraviolet (SSBUV); Polymer Morphology (PM) experiments; IMAX camera project; Mesoscale Lightning Experiment (MLE); Air Force Maui Optical Site (AMOS) experiment; Growth Hormone Concentration and Distribution (GHCD) in Plants experiment; Sensor Technology Experiment (STEX); SSIP Student Experiment (SE) 82-15; Ice Crystals Experiment

STS-33 Mission Facts — Discovery — Nov. 22–27, 1989

Commander: Frederick D. Gregory

Pilot: John E. Blaha

Mission Specialist: F. Story Musgrave

Mission Specialist: Kathryn C. Thornton

Mission Specialist: Manley L. Carter Jr.

Mission Duration: 120 hours (5 days), 6 minutes, 49 seconds

Miles Traveled: 2 million statute miles

Inclination: 28.45 degrees

Orbits of Earth: 78

Landed: Concrete runway 04 at Edwards Air Force Base, Calif.

Payload: DOD

STS-32 Mission Facts — Columbia — Jan. 9–20, 1990

Commander: Daniel C. Brandenstein

Pilot: James D. Wetherbee

Mission Specialist: Bonnie J. Dunbar

Mission Specialist: G. David Low

Mission Specialist: Marsha S. Ivins

Mission Duration: 240 hours (10 days), 21 hours, 37 seconds

Miles Traveled: 4,509,972 statute miles

Inclination: 28.5 degrees

Orbits of Earth: 171

Orbital Altitude: 194 nautical miles (233 statute miles)

Liftoff Weight: Approximately 4,519,487 pounds

Orbiter Weight at Liftoff: Approximately 255,994 pounds

Payload Weight Up: Approximately 26,488 pounds

Payload Weight Down: Approximately 21,393 pounds

STS-32 Mission Facts (Cont)

Orbiter Weight at Landing: Approximately 228,335 pounds

Landed: Concrete runway 22 at Edwards Air Force Base, Calif. (night landing)

Payload: Deployment of Syncom IV-5; retrieval of Long Duration Exposure Facility (LDEF); Fluids Experiment Apparatus (FEA)-3; Protein Crystal Growth (PCG) III-2; Latitude/Longitude Locator (L3); American Flight Echocardiograph (AFE); Characterization of Neurospora Circadian Rhythms in Space (CNCR)-01; Air Force Maui Optical Site (AMOS)-4; Mesoscale Lightning Experiment (MLE); IMAX; Interim Operational Contamination Monitor (IOCM)

STS-36 Mission Facts — Atlantis — Feb. 28–March 4, 1990

Commander: John O. Creighton

Pilot: John H. Casper

Mission Specialist: David C. Hilmers

Mission Specialist: Richard M. Mullane

Mission Specialist: Pierre J. Thuot

Mission Duration: 96 hours (4 days), 10 hours, 18 minutes, 23 seconds

Inclination: 62 degrees

Landed: Runway 23 dry lake bed at Edwards Air Force Base, Calif.

Payload: DOD

STS-31 Mission Facts — Discovery — April 24–29, 1990

Commander: Loren J. Shriver

Pilot: Charles F. Bolden

Mission Specialist: Steven A. Hawley

Mission Specialist: Bruce McCandless II

Mission Specialist: Kathryn D. Sullivan

Mission Duration: 120 hours (5 days), 1 hour, 16 minutes, 5 seconds

Miles Traveled: 2,068,213 statute miles

Inclination: 28.45 degrees

Orbits of Earth: 76

Orbital Altitude: 334 nautical miles (384 statute miles)

Liftoff Weight: Approximately 4,514,665 pounds

Orbiter Weight at Liftoff: Approximately 249,109 pounds

Payload Weight Up: Approximately 28,673 pounds

Payload Weight Down: Approximately 4,768 pounds

Orbiter Weight at Landing: Approximately 189,118 pounds

STS-31 Mission Facts (Cont)

Landed: Concrete runway 22 at Edwards Air Force Base, Calif.

Payload: Deployment of Hubble Space Telescope; IMAX camera in payload bay and in crew compartment; Protein Crystal Growth III-03; Investigation Into Polymer Membrane Processing-01; Air Force Maui Optical Site-05; Radiation Monitoring Equipment III-01; Student Experiment 82-16; and Ascent Particle Monitor 01

STS-41 Mission Facts — Discovery — Oct. 6–10, 1990

Commander: Richard N. Richards

Pilot: Robert D. Cabana

Mission Specialist: Bruce E. Melnick

Mission Specialist: William M. Shepherd

Mission Specialist: Thomas D. Akers

Mission Duration: 96 hours (4 days), 2 hours, 10 minutes

Miles Traveled: 1,707,445 statute miles

Inclination: 28.5 degrees

Orbits of Earth: 65

Orbital Altitude: 177 nautical miles (203 statute miles)

Liftoff Weight: Approximately 4,523,894 pounds

Orbiter Weight at Liftoff: Approximately 293,019 pounds

Payload Weight Up: Approximately 48,812 pounds

Payload Weight Down: Approximately 10,279 pounds

Orbiter Weight at Landing: Approximately 197,986 pounds

Landed: Concrete runway 22 at Edwards Air Force Base, Calif.

Payload: Deploy Ulysses; Shuttle Solar Backscatter Ultraviolet; Intelsat Solar Array Coupon; Solid-Surface Combustion Experiment; Investigations Into Polymer Membrane Processing; Chromosome and Plant Cell Division in Space; Physiological Systems Experiment; Voice Command System; Radiation Monitoring Equipment III; Air Force Maui Optical Site

STS-38 Mission Facts — Atlantis — Nov. 15–20, 1990

Commander: Richard O. Covey

Pilot: Frank L. Culbertson

Mission Specialist: Robert C. Springer

Mission Specialist: Carl J. Meade

Mission Specialist: Charles D. "Sam" Gemar

Mission Duration: 96 hours (4 days), 21 hours, 55 minutes, 22 seconds

STS-38 Mission Facts (Cont)

Orbits of Earth: 79

Inclination: 28.5 degrees

Landed: Runway 33 at Kennedy Space Center, Fla.

Payload: DOD

STS-35 Mission Facts — Columbia — Dec. 2–10, 1990

Commander: Vance D. Brand

Pilot: Guy S. Gardner

Mission Specialist: Jeffrey A. Hoffman

Mission Specialist: John M. Lounge

Mission Specialist: Robert A.R. Parker

Payload Specialist: Samuel T. Durrance

Payload Specialist: Ronald A. Parise

Mission Duration: 192 hours (8 days), 23 hours,
5 minutes, 8 seconds

Miles Traveled: 3,728,636 statute miles

Inclination: 28.45 degrees

Orbits of Earth: 142

Orbital Altitude: 190 nautical miles (218 statute miles)

Liftoff Weight: Approximately 4,523,199 pounds

Orbiter Weight at Liftoff: Approximately 267,392
pounds

Payload Weight Up: Approximately 26,330 pounds

Payload Weight Down: Approximately 26,330 pounds

Orbiter Weight at Landing: Approximately 225,886
pounds

Landed: Concrete runway 22 at Edwards Air Force
Base, Calif.

Payload: Ultraviolet Astronomy Telescope (Astro);
Broad-Band X-Ray Telescope (BBXRT); Shuttle
Amateur Radio Experiment (SAREX); Air Force
Maui Optical Site (AMOS)

STS-37 Mission Facts — Atlantis — April 5–11, 1991

Commander: Steven R. Nagel

Pilot: Kenneth D. Cameron

Mission Specialist: Jerry L. Ross

Mission Specialist: Jerome Apt

Mission Specialist: Linda M. Godwin

Mission Duration: 120 hours (5 days), 23 hours,
32 minutes, 44 seconds

Miles Traveled: 2,456,263 statute miles

Inclination: 28.45 degrees

Orbits of Earth: 93

Orbital Altitude: 243 nautical miles (280 statute miles)

Liftoff Weight: Approximately 4,519,158 pounds

STS-37 Mission Facts (Cont)

Orbiter Weight at Liftoff: Approximately 254,971 pounds

Payload Weight Up: Approximately 36,621 pounds

Payload Weight Down: Approximately 2,279 pounds

Orbiter Weight at Landing: Approximately 191,050 pounds

Landed: Runway 33 dry lake bed at Edwards Air Force Base, Calif.

Payload: Gamma-Ray Observatory (GRO); Crew/Equipment Translation Aids (part of Extravehicular Activity Development Flight Experiment); Ascent Particle Monitor (APM); Bioserve Instrumentation Technology Associates Materials Dispersion Apparatus (BIMDA); Protein Crystal Growth (PCG)-Block II; Space Station Heatpipe Advanced Radiator Element (SHARE)-II; Shuttle Amateur Radio Experiment (SAREX)-II; Radiation Monitoring Equipment (RME)-III; Air Force Maui Optical Site (AMOS) Calibration Test

Extravehicular Activity (EVA) conducted by Jerry L. Ross and Jerome Apt during two spacewalks for a total of 10 hours, 49 minutes. EVA 1, 4 hours, 38 minutes; EVA 2, 6 hours, 11 minutes. EVA 1 was an unscheduled EVA to manually deploy the Gamma-Ray Observatory's high-gain antenna, which failed to deploy upon ground command. Following the successful deploy of the antenna, the astronauts spent the remainder of the EVA on Extravehicular Activity Development Flight Experiment activities.

STS-39 Mission Facts — Discovery — April 28–May 6, 1991

Commander: Michael L. Coats

Pilot: L. Blaine Hammond Jr.

Mission Specialist: Gregory J. Harbaugh

Mission Specialist: Donald R. McMonagle

Mission Specialist: Guion S. Bluford Jr.

Mission Specialist: Charles L. (Lacy) Veach

Mission Specialist: Richard J. Hieb

Mission Duration: 192 hours (8 days), 7 hours, 22 minutes, 22 seconds

Miles Traveled: Approximately 3.47 million statute miles

Inclination: 57 degrees

Orbits of Earth: 134

Orbital Altitude: 140 nautical miles (161 statute miles)

Liftoff Weight: Approximately 4,512,698 pounds

Orbiter Weight at Liftoff: Approximately 246,986 pounds

Payload Weight Up: Approximately 21,413 pounds

Payload Weight Down: Approximately 20,586 pounds

STS-39 Mission Facts (Cont)

Orbiter Weight at Landing: Approximately 210,811 pounds

Landed: Runway 15 at Kennedy Space Center, Fla.

Payload: Infrared Background Signature Survey (IBSS); Air Force Program (AFP)-675; Space Test Payload (STP)-I; Multi-Purpose Experiment Canister (MPEC); Cloud Logic to Optimize Use of Defense Systems (CLOUDS)-1A; Radiation Monitoring Equipment (RME)-III

STS-40 Mission Facts — Columbia — June 5–14, 1991

Commander: Bryan D. O'Conner

Pilot: Sidney M. Gutierrez

Mission Specialist: M. Rhea Seddon

Mission Specialist: James P. Bagian

Mission Specialist: Tamara E. Jernigan

Payload Specialist: F. Drew Gaffney

Payload Specialist: Millie Hughes-Fulford

Mission Duration: 216 hours (9 days), 2 hours, 14 minutes, 20 seconds

Miles Traveled: Approximately 3,779,940 statute miles

Inclination: 39 degrees

Orbits of Earth: 146

Orbital Altitude: 160 nautical miles (184 statute miles)

Liftoff Weight: Approximately 4,519,081 pounds

Orbiter Weight at Liftoff: Approximately 250,398 pounds

Payload Weight Up: Approximately 25,942 pounds

Payload Weight Down: Approximately 25,942 pounds

Orbiter Weight at Landing: Approximately 226,534 pounds

Landed: Concrete runway 22 at Edwards AFB, Calif.

Payload: Spacelab Life Sciences (SLS)-1 with long module; getaway special bridge assembly with 12 getaway specials; Physiological Monitoring System (PMS); Urine Monitoring System (UMS); Animal Enclosure Modules (AEM); Middeck Zero-gravity Dynamics Experiment (MODE); 7 Orbiter Experiments Program experiments

STS-43 Mission Facts — Atlantis — Aug. 2–11, 1991

Commander: John E. Blaha

Pilot: Michael A. Baker

Mission Specialist: Shannon W. Lucid

Mission Specialist: G. David Low

Mission Specialist: James C. Adamson

Mission Duration: 192 hours (8 days), 21 hours, 21 minutes, 25 seconds

STS-43 Mission Facts (Cont)

Miles Traveled: Approximately 3,700,400 statute miles

Inclination: 28.45 degrees

Orbits of Earth: 142

Orbital Altitude: 160 nautical miles (184 statute miles)

Liftoff Weight: Approximately 4,526,488 pounds

Orbiter Weight at Liftoff: Approximately 259,382 pounds

Payload Weight Up: Approximately 46,882 pounds

Payload Weight Down: Approximately 9,242 pounds

Orbiter Weight at Landing: Approximately 196,735 pounds

Landed: Runway 15 at Kennedy Space Center, Fla.

Payload: Tracking and Data Relay Satellite

(TDRS)-E/Inertial Upper Stage (IUS); Space Station Heatpipe Advanced Radiator Element (SHARE)-II; Shuttle Solar Backscatter Ultraviolet (SSBUV) instrument 03; Optical Communications Through the Shuttle Window (OCTW); Air Force Maui Optical Site (AMOS) Calibration Test; Auroral Photography Experiment (APE)-B; Bioserve-Instrumentation Technology Associates Materials Dispersion Apparatus (BIMDA)-02; Investigations Into Polymer Membrane Processing (IPMP)-03; Protein Crystal Growth III Block II; Space Acceleration Measurement System (SAMS); Solid Surface Combustion Experiment (SSCE)-02; Tank Pressure Control Experiment (TPCE)

STS-48 Mission Facts — Discovery — Sept. 12–18, 1991

Commander: John O. Creighton

Pilot: Kenneth S. Reightler Jr.

Mission Specialist: James F. Buchli

Mission Specialist: Mark N. Brown

Mission Specialist: Charles D. "Sam" Gemar

Mission Duration: 120 hours (5 days), 8 hours, 27 minutes, 34 seconds

Miles Traveled: Approximately 2,193,670 statute miles

Inclination: 57 degrees

Orbits of Earth: 81

Orbital Altitude: 308 nautical miles (355 statute miles)

Liftoff Weight: Approximately 4,507,348 pounds

Orbiter Weight at Liftoff: Approximately 239,735 pounds

Payload Weight Up: Approximately 17,317 pounds

Payload Weight Down: Approximately 2,898 pounds

Orbiter Weight at Landing: Approximately 192,507 pounds

Landed: Concrete runway 22 at Edwards Air Force Base, Calif.

STS-48 Mission Facts (Cont)

Payload: Upper Atmosphere Research Satellite (UARS); Ascent Particle Monitor (APM)-03; Physiological and Anatomical Rodent Experiment (PARE)-01; Protein Crystal Growth (PCG)-II-2; Middeck Zero-Gravity Dynamics Experiment (MODE)-01; Investigations Into Polymer Membrane Processing (IPMP)-04; Cosmic Radiation Effects and Activation Monitor (CREAM-02); Radiation Monitoring Equipment (RME)-III-06; Shuttle Activation Monitor (SAM)-03; Air Force Maui Optical Site (AMOS) Calibration Test

STS-44 Mission Facts — Atlantis — Nov. 24–Dec. 1, 1991

Commander: Frederick D. Gregory

Pilot: Terrence T. Henricks

Mission Specialist: F. Story Musgrave

Mission Specialist: Mario Runco Jr.

Mission Specialist: James S. Voss

Payload Specialist: Thomas J. Hennen

Mission Duration: 144 hours (6 days), 22 hours, 50 minutes, 42 seconds

Miles Traveled: Approximately 2,890,067 statute miles

Inclination: 28.45 degrees

Orbits of Earth: 109

Orbital Altitude: 195 nautical miles (225 statute miles)

Liftoff Weight: Approximately 4,526,272 pounds

Orbiter Weight at Liftoff: Approximately 259,629 pounds

Payload Weight Up: Approximately 44,628 pounds

Payload Weight Down: Approximately 7,010 pounds

Orbiter Weight at Landing: Approximately 193,825 pounds

Landed: Runway 05 dry lake bed at Edwards Air Force Base, Calif.

Payload: Defense Support Program satellite/Inertial Upper Stage; Interim Operational Contamination Monitor; Terra Scout; Military Man in Space; Shuttle Activation Monitor; Cosmic Radiation Effects and Activation Monitor; Radiation Monitoring Equipment III; Air Force Maui Optical Site Calibration Test; Ultraviolet Plume Instrument; Visual Function Tester 1

STS-42 Mission Facts — Discovery — Jan. 22–30, 1992

Commander: Ronald J. Grabe

Pilot: Stephen S. Oswald

Mission Specialist: David C. Hilmers

Mission Specialist: Norman E. Thagard

STS-42 Mission Facts (Cont)

Mission Specialist: William F. Readdy

Payload Specialist: Ulf D. Merbold

Payload Specialist: Roberta L. Bondar

Mission Duration: 192 hours (8 days), 1 hour,
14 minutes, 45 seconds

Miles Traveled: Approximately 3,359,830 statute miles

Inclination: 57 degrees

Orbits of Earth: 129

Orbital Altitude: 163 nautical miles (188 statute miles)

Liftoff Weight: Approximately 4,507,474 pounds

Orbiter Weight at Liftoff: Approximately
243,395 pounds

Payload Weight Up: Approximately 28,663 pounds

Payload Weight Down: Approximately 28,663 pounds

Orbiter Weight at Landing: Approximately
218,016 pounds

Landed: Concrete runway 22 at Edwards Air Force
Base, Calif.

Payload: International Microgravity Laboratory (IML)-1;
getaway special (GAS) bridge with 10 getaway
specials; IMAX camera; Gelation of Sols: Applied
Microgravity Research (GOSAMR)-1; Investiga-
tions Into Polymer Membrane Processing (IPMP);
Radiation Monitoring Equipment (RME)-III; Student
Experiment 81-09: Convection in Zero Gravity;
Student Experiment 83-02: Capillary Rise of Liquid
Through Granular Porous Media

STS-45 Mission Facts — Atlantis — March 24–April 2, 1992

Commander: Charles F. Bolden

Pilot: Brian Duffy

Payload Commander: Kathryn D. Sullivan

Mission Specialist: David C. Leestma

Mission Specialist: C. Michael Foale

Payload Specialist: Dirk D. Frimout

Payload Specialist: Byron K. Lichtenberg

Mission Duration: 192 hours (8 days), 22 hours,
9 minutes, 25 seconds

Miles Traveled: Approximately 3,724,946 statute miles

Inclination: 57 degrees

Orbits of Earth: 143

Orbital Altitude: 160 nautical miles (184 statute miles)

Liftoff Weight: Approximately 4,496,035 pounds

Orbiter Weight at Liftoff: Approximately
233,650 pounds

Payload Weight Up: Approximately 17,683 pounds

Payload Weight Down: Approximately 17,683 pounds

Orbiter Weight at Landing: Approximately
205,042 pounds

STS-45 Mission Facts (Cont)

Landed: Concrete runway 33 at Kennedy Space Center, Fla.

Payload: Atmospheric Laboratory for Applications and Science (ATLAS)-1; Shuttle Solar Backscatter Ultraviolet (SSBUV)-4; Getaway Special Experiment G-229; Space Tissue Loss (STL)-1; Radiation Monitoring Equipment (RME)-III; Visual Function Tester (VFT)-II; Cloud Logic To Optimize Use of Defense Systems (CLOUDS)-1A; Investigations Into Polymer Membrane Processing (IPMP); Shuttle Amateur Radio Experiment (SAREX)-II; Ultraviolet Plume Instrument (UVPI)

STS-49 Mission Facts — Endeavour — May 7–16, 1992

Commander: Daniel C. Brandenstein

Pilot: Kevin P. Chilton

Mission Specialist: Pierre J. Thuot

Mission Specialist: Kathryn C. Thornton

Mission Specialist: Richard J. Hieb

Mission Specialist: Thomas D. Akers

Mission Specialist: Bruce E. Melnick

Mission Duration: 192 hours (8 days), 21 hours, 17 minutes, 39 seconds

Miles Traveled: Approximately 3,696,019 statute miles

Inclination: 28.35 degrees

Orbits of Earth: 141

Orbital Altitude: 183 nautical miles (211 statute miles)

Liftoff Weight: Approximately 4,519,238 pounds

Orbiter Weight at Liftoff: Approximately 256,597 pounds

Payload Weight Up: Approximately 32,598 pounds

Payload Weight Down: Approximately 8,558 pounds

Orbiter Weight at Landing: Approximately 201,649 pounds

Landed: Concrete runway 22 at Edwards Air Force Base, Calif.

Payload: Intelsat-VI reboost mission hardware; Assembly of Station by EVA Methods (ASEM); Commercial Protein Crystal Growth (CPCG); Air Force Maui Optical Site (AMOS) Calibration Test; Ultraviolet Plume Instrument (UVPI)

Extravehicular Activity (EVA) conducted by Pierre Thuot, Richard J. Hieb, Thomas D. Akers, and Kathryn C. Thornton during four spacewalks for a total of 25 hours, 27 minutes. EVA 1, Thuot and Hieb, 3 hours, 43 minutes; EVA 2, Thuot and Hieb, 5 hours, 30 minutes; EVA 3, Thuot, Hieb, and Akers, 8 hours, 29 minutes (first three-person EVA); and EVA 4, Thornton and Akers, 7 hours, 45 minutes.

STS-49 Mission Facts (Cont)

During EVAs 1 and 2, Thuot and Hieb attempted unsuccessfully to retrieve the Intelsat-VI satellite using a capture bar. On EVA 3, Thuot, Hieb, and Akers manually captured the satellite, which was subsequently repaired and redeployed. EVA 4 was used to evaluate Space Station assembly by EVA methods.

Of Note: First active dual rendezvous of two orbiting spacecraft (Endeavour and Intelsat-VI)

First deployment of a drag chute on the orbiter fleet

STS-50 Mission Facts — Columbia — June 25–July 9, 1992

Commander: Richard N. Richards

Pilot: Kenneth D. Bowersox

Payload Commander: Bonnie J. Dunbar

Mission Specialist: Ellen S. Baker

Mission Specialist: Carl J. Meade

Payload Specialist: Lawrence J. DeLucas

Payload Specialist: Eugene H. Trinh

Mission Duration: 312 hours (13 days), 19 hours,
30 minutes, 4 seconds

Miles Traveled: Approximately 5,758,000 statute miles

Inclination: 28.45 degrees

Orbits of Earth: 221

Orbital Altitude: 160 nautical miles (184 statute miles)

Liftoff Weight: Approximately 4,519,680 pounds

Orbiter Weight at Liftoff: Approximately
257,265 pounds

Payload Weight Up: Approximately 24,589 pounds

Payload Weight Down: Approximately 24,589 pounds

Orbiter Weight at Landing: Approximately 228,127
pounds

Landed: Runway 33 at Kennedy Space Center, Fla.

Payload: United States Microgravity Laboratory (USML)-1; Orbital Acceleration Research Experiment (OARE); Investigations Into Polymer Membrane Processing (IPMP); Shuttle Amateur Radio Experiment (SAREX)-II; Ultraviolet Plume Instrument (UVPI)

Of Note: First extended-duration mission

STS-46 Mission Facts — Atlantis — July 31–Aug. 8, 1992

Commander: Loren J. Shriver

Pilot: Andrew M. Allen

Payload Commander: Jeffrey A. Hoffman

Mission Specialist: Franklin R. Chang-Diaz

Mission Specialist: Claude Nicollier

STS-46 Mission Facts (Cont)

Mission Specialist: Marsha S. Ivins
Payload Specialist: Franco Malerba
Mission Duration: 168 hours (7 days), 23 hours, 16 minutes, 7 seconds
Miles Traveled: Approximately 3,321,007 statute miles
Inclination: 28.45 degrees
Orbits of Earth: 127
Orbital Altitude: 127 nautical miles (146 statute miles)
Liftoff Weight: Approximately 4,516,789 pounds
Orbiter Weight at Liftoff: Approximately 256,031 pounds
Payload Weight Up: Approximately 28,585 pounds
Payload Weight Down: Approximately 18,594 pounds
Orbiter Weight at Landing: Approximately 208,806 pounds
Landed: Runway 33 at Kennedy Space Center, Fla.
Payload: Tethered Satellite System (TSS)-1; European Retrievable Carrier (EURECA)-1L; Evaluation of Oxygen Integration With Materials (EOIM)-III/Thermal Energy Management Processes (TEMP)-2A; Consortium for Materials Development In Space Complex Autonomous Payloads (CONCAP)-II and III; IMAX Cargo Bay Camera (ICBC); Limited-Duration Space Environment Candidate Materials Exposure (LDCE); Pituitary Growth Hormone Cell Function (PHCF); Ultraviolet Plume Instrument (UVPI)

STS-47 Mission Facts — Endeavour — Sept. 12–20, 1992

Commander: Robert L. Gibson
Pilot: Curtis L. Brown Jr.
Mission Specialist: Mark C. Lee
Mission Specialist: Jerome Apt
Mission Specialist: N. Jan Davis
Mission Specialist: Mae C. Jemison
Payload Specialist: Mamoru Mohri
Mission Duration: 168 hours (7 days), 22 hours, 31 minutes, 11 seconds
Miles Traveled: Approximately 3,310,922 statute miles
Inclination: 57 degrees
Orbits of Earth: 127
Orbital Altitude: 163 nautical miles (188 statute miles)
Liftoff Weight: Approximately 4,506,649 pounds
Orbiter Weight at Liftoff: Approximately 244,413 pounds
Payload Weight Up: Approximately 28,158 pounds
Payload Weight Down: Approximately 28,158 pounds
Orbiter Weight at Landing: Approximately 219,327 pounds
Landed: Runway 33 at Kennedy Space Center, Fla.

STS-47 Mission Facts (Cont)

Payload: Spacelab-J; nine getaway special canister experiments; Israel Space Agency Investigation About Hornets (ISAIAH); Shuttle Amateur Radio Experiment (SAREX) II; Solid Surface Combustion Experiment (SSCE)

STS-52 Mission Facts — Columbia — Oct. 22–Nov. 1, 1992

Commander: James D. Wetherbee

Pilot: Michael A. Baker

Mission Specialist: William M. Shepherd

Mission Specialist: Tamara E. Jernigan

Mission Specialist: Charles Lacy Veach

Payload Specialist: Steven MacLean

Mission Duration: 216 hours (9 days), 20 hours,
56 minutes, 13 seconds

Miles Traveled: Approximately 4,129,028 statute miles

Inclination: 28.45 degrees

Orbits of Earth: 159

Orbital Altitude: 160 nautical miles (184 statute miles)

Liftoff Weight: Approximately 4,514,325 pounds

Orbiter Weight at Liftoff: Approximately 250,130 pounds

Payload Weight Up: Approximately 20,077 pounds

Payload Weight Down: Approximately 14,419 pounds

Orbiter Weight at Landing: Approximately 215,114
pounds

Landed: Runway 33 at Kennedy Space Center, Fla.

Payload: Laser Geodynamic Satellite (LAGEOS) II/
Italian Research Interim Stage (IRIS); Canadian
Experiments (CANEX) 2; United States Micrograv-
ity Payload (USMP) 1; Attitude Sensor Pack-age
(ASP); Tank Pressure Control Experiment (TPCE);
Physiological Systems Experiment (PSE); Heat
Pipe Performance (HPP) experiment; Commercial
Protein Crystal Growth (CPCG); Shuttle Plume
Impingement Experiment (SPIE); Commercial Ma-
terials ITA Experiment (CMIX); Crystals by Vapor
Transport Experiment (CVTE)

STS-53 Mission Facts — Discovery — Dec. 2–9, 1992

Commander: David M. Walker

Pilot: Robert D. Cabana

Mission Specialist: Guion S. Bluford

Mission Specialist: James S. Voss

Mission Specialist: Michael Richard "Rich" V. Clifford

Mission Duration: 168 hours (7 days), 7 hours,
19 minutes, 17 seconds

STS-53 Mission Facts (Cont)

Miles Traveled: Approximately 3,034,680 statute miles

Inclination: 57 degrees

Orbits of Earth: 116

Orbital Altitude: 200 nautical miles (230 statute miles)

Liftoff Weight: Approximately 4,506,642 pounds

Orbiter Weight at Liftoff: Approximately 243,952 pounds

Payload Weight Up: Approximately 26,166 pounds

Payload Weight Down: Approximately 5,151 pounds

Orbiter Weight at Landing: Approximately 193,215 pounds

Landed: Concrete runway 22 at Edwards Air Force Base, Calif.

Payload: Department of Defense (DOD)1; Glow Experiment/Cryogenic Heat Pipe Experiment Payload (GCP); Battlefield Laser Acquisition Sensor Test (BLAST); Cloud Logic To Optimize Use of Defense Systems (CLOUDS) 1A; Cosmic Radiation Effects and Activation Monitor (CREAM); Fluid Acquisition and Resupply Equipment (FARE); Hand-held, Earth-oriented, Real-time, Cooperative, User-friendly, Location-targeting and Environmental System (HERCULES); Microencapsulation in Space (MIS)-1; Radiation Monitoring Equipment (RME) III; Spare Tissue Loss (STL); Visual Function Tester (VFT)2; and Orbital Debris Radar Calibration System (ODERACS). The ODERACS payload was unable to be deployed because of payload equipment malfunction.

STS-54 Mission Facts — Endeavour — Jan. 13–19, 1993

Commander: John H. Casper

Pilot: Donald R. McMonagle

Mission Specialist 1: Mario Runco Jr.

Mission Specialist 2: Gregory J. Harbaugh

Mission Specialist 3: Susan J. Helms

Mission Duration: 120 hours (5 days), 23 hours, 38 minutes, 17 seconds

Miles Traveled: Approximately 2,501,277 statute miles

Inclination: 28.45 degrees

Orbits of Earth: 96

Orbital Altitude: 160 nautical miles (184 statute miles)

Liftoff Weight: Approximately 4,522,692 pounds

Orbiter Weight at Liftoff: Approximately 259,264 pounds

Payload Weight Up: Approximately 46,643 pounds

Payload Weight Down: Approximately 9,068 pounds

Orbiter Weight at Landing: Approximately 197,778 pounds

STS-54 Mission Facts (Cont)

Landed: Concrete runway 33 at Kennedy Space Center, Fla.

Payload: Tracking and Data Relay Satellite (TDRS)-F/ Inertial Upper Stage (IUS); Diffuse X-ray Spectrometer (DXS); Chromosome and Plant Cell Division in Space (CHROMEX); Commercial Generic Bioprocessing Apparatus (CGBA) A; Physiological and Anatomical Rodent Experiment (PARE) 02; Solid Surface Combustion Experiment (SSCE)

Extravehicular Activity (EVA) conducted by Gregory J. Harbaugh and Mario Runco Jr., 4 hours, 28 minutes.

STS-56 Mission Facts — Discovery — April 8–17, 1993

Commander: Kenneth Cameron

Pilot: Stephen S. Oswald

Mission Specialist 1: Michael Foale

Mission Specialist 2: Kenneth D. Cockrell

Mission Specialist 3: Ellen Ochoa

Mission Duration: 216 hours (9 days) 6 hours, 8 minutes, 23 seconds

Miles Traveled: Approximately 3,853,997 statute miles

Inclination: 57 degrees

Orbits of Earth: 148

Orbital Altitude: 160 nautical miles (184 statute miles)

Liftoff Weight: Approximately 4,500,815 pounds

Orbiter Weight at Liftoff: Approximately 236,659 pounds

Payload Weight Up: Approximately 16,406 pounds

Payload Weight Down: Approximately 16,406 pounds

Orbiter Weight at Landing: Approximately 206,855 pounds

Landed: Concrete runway 33 at Kennedy Space Center, Fla.

Payload: Atmospheric Laboratory for Applications and Science (ATLAS) 2; Shuttle Solar Backscatter Ultraviolet (SSBUV) A; Shuttle Pointed Autonomous Research Tool for Astronomy (SPARTAN) 201 (Solar Wind Generation Experiment); Solar Ultraviolet Experiment (SUVE); Commercial Material Dispersion Apparatus (CMIX); Physiological and Anatomical Rodent Experiment (PARE); Hand-held, Earth-oriented, Real-time, Cooperative, User-friendly, Location-targeting, and Environmental System (HERCULES); Shuttle Amateur Radio Experiment (SAREX) II; Space Tissue Loss (STL); Air Force Maui Optical Site (AMOS); Cosmic Radiation Effects and Activation Monitor (CREAM); Radiation Monitoring Equipment (RME) III

**STS-55 Mission Facts — Columbia —
April 26–May 6, 1993**

Commander: Steven R. Nagel

Pilot: Terrence T. Henricks

Payload Commander: Jerry L. Ross

Mission Specialist 2: Charles J. Precourt

Mission Specialist 3: Bernard A. Harris Jr.

Payload Specialist 1: Ulrich Walter, Germany

Payload Specialist 2: Hans Schlegel, Germany

Mission Duration: 216 hours (9 days) 23 hours, 39 minutes, 59 seconds

Miles Traveled: Approximately 4,164,183 statute miles

Inclination: 28.45 degrees

Orbits of Earth: 160

Orbital Altitude: 160 nautical miles (184 statute miles)

Liftoff Weight: Approximately 4,518,784 pounds

Orbiter Weight at Liftoff: Approximately 255,252 pounds

Payload Weight Up: Approximately 26,864 pounds

Payload Weight Down: Approximately 26,864 pounds

Orbiter Weight at Landing: Approximately 227,203 pounds

Landed: Concrete runway 22 at Edwards Air Force Base, Calif.

Payload: Spacelab D-2 with long module, unique support structure (USS); Reaction Kinetics in Glass Melts (RKGM) getaway special; Shuttle Amateur Radio Experiment (SAREX) II

**STS-57 Mission Facts — Endeavour —
June 21–July 1, 1993**

Commander: Ronald J. Grabe

Pilot: Brian J. Duffy

Payload Commander: G. David Low

Mission Specialist 2: Nancy J. Sherlock

Mission Specialist 3: Peter J.K. "Jeff" Wisoff

Mission Specialist 4: Janice E. Voss

Mission Duration: 216 hours (9 days), 23 hours, 44 minutes, 54 seconds

Miles Traveled: Approximately 4,118,037 statute miles

Inclination: 28.45 degrees

Orbits of Earth: 155

Orbital Altitude: 250 nautical miles (287 statute miles)

Liftoff Weight: Approximately 4,516,459 pounds

Orbiter Weight at Liftoff: Approximately 252,359 pounds

Payload Weight Up: Approximately 19,691 pounds

Payload Weight Down: Approximately 28,925 pounds

Orbiter Weight at Landing: Approximately 244,400 pounds

STS-57 Mission Facts (Cont)

Landed: Concrete runway 33 at Kennedy Space Center, Fla.

Payload: SPACEHAB 01; retrieval of European Retrievable Carrier (EURECA) Satellite; Superfluid Helium On-Orbit Transfer (SHOOT); Consortium for Materials Development in Space Complex Autonomous Payload (CONCAP)-IV; Fluid Acquisition and Re-supply Experiment (FARE); Shuttle Amateur Radio Experiment (SAREX) II; Air Force Maui Optical Site (AMOS); GAS bridge assembly with 12 getaway special payloads

Extravehicular Activity (EVA) conducted by David Low and Jeff Wisoff, 5 hours, 50 minutes. Low and Wisoff conducted tests to refine procedures being developed to service the Hubble Space Telescope and to prepare for construction of the International Space Station.

STS-51 Mission Facts — Discovery — Sept. 12–22, 1993

Commander: Frank L. Culbertson Jr.

Pilot: William F. Readdy

Mission Specialist 1: James H. Newman

Mission Specialist 2: Daniel W. Bursch

Mission Specialist 3: Carl E. Walz

Mission Duration: 216 hours (9 days), 20 hours, 11 minutes, 11 seconds

Miles Traveled: Approximately 4,106,411 statute miles

Inclination: 28.45 degrees

Orbits of Earth: 158

Orbital Altitude: 160 nautical miles (185 statute miles)

Liftoff Weight: Approximately 4,525,870 pounds

Orbiter Weight at Liftoff: Approximately 261,597 pounds

Payload Weight Up: Approximately 42,682 pounds

Payload Weight Down: Approximately 8,567 pounds

Orbiter Weight at Landing: Approximately 206,438 pounds

Landed: Concrete runway 15 at Kennedy Space Center, Fla.

Payload: Advanced Communication Technology Satellite (ACTS)/Transfer Orbit Stage (TOS); Orbiting Retrievable Far and Extreme Ultraviolet Spectrometer— Shuttle Pallet Satellite (ORFEUS-SPAS) with Remote IMAX Camera System (RICS); Limited Duration Space Environment Candidate Materials Exposure (LDCE) (Beam Configuration C); Commercial Protein Crystal Growth (CPCG—Block II); Chromosome and Plant Cell Division in Space (CHROMEX);

STS-51 Mission Facts (Cont)

High-Resolution Shuttle Glow Spectroscopy-A (HRSGS-A); Auroral Photography Experiment-B (APE-B); Investigation Into Polymer Membrane Processing (IPMP); Radiation Monitoring Equipment (RME-III); Air Force Maui Optical Site Calibration Test (AMOS); IMAX In-Cabin Camera

Extravehicular Activity (EVA) conducted by Carl E. Walz and James H. Newman, 7 hours, 5 minutes. Walz and Newman conducted tests in support of the Hubble Space Telescope first servicing mission and future EVAs, including International Space Station assembly and maintenance.

Of Note: First night landing at KSC

STS-58 Mission Facts — Columbia — Oct. 18–Nov. 1, 1993

Commander: John E. Blaha

Pilot: Richard A. Searfoss

Payload Commander: M. Rhea Seddon

Mission Specialist: Shannon W. Lucid

Mission Specialist: David A. Wolf

Mission Specialist: William S. McArthur Jr.

Payload Specialist: Martin J. Fettman

Mission Duration: 336 hours (14 days), 0 hours, 12 minutes, 32 seconds

Miles Traveled: Approximately 5,840,450 statute miles

Inclination: 39 degrees

Orbits of Earth: 225

Orbital Altitude: 153 nautical miles (176 statute miles)

Liftoff Weight: Approximately 4,519,968 pounds

Orbiter Weight at Liftoff: Approximately 256,007 pounds

Payload Weight Up: Approximately 23,188 pounds

Payload Weight Down: Approximately 23,188 pounds

Orbiter Weight at Landing: Approximately 229,753 pounds

Landed: Concrete runway 22 at Edwards Air Force Base, Calif.

Payload: Spacelab Life Sciences (SLS) 2; Shuttle Amateur Radio Experiment (SAREX) II

STS-61 Mission Facts — Endeavour — Dec. 2–13, 1993

Commander: Richard O. Covey

Pilot: Kenneth Bowersox

Payload Commander: F. Story Musgrave

Mission Specialist: Thomas D. Akers

Mission Specialist: Jeffrey A. Hoffman

Mission Specialist: Kathryn C. Thornton

STS-61 Mission Facts (Cont)

Mission Specialist: Claude Nicollier, European Space Agency

Mission Duration: 240 hours (10 days), 19 hours, 58 minutes, 33 seconds

Miles Traveled: Approximately 4,433,772 statute miles

Inclination: 28.45 degrees

Orbits of Earth: 163

Orbital Altitude: 311 nautical miles (358 statute miles)

Liftoff Weight: Approximately 4,515,150 pounds

Orbiter Weight at Liftoff: Approximately 250,314 pounds

Payload Weight Up: Approximately 17,662 pounds

Payload Weight Down: Approximately 17,662 pounds

Orbiter Weight at Landing: Approximately 211,210 pounds

Landed: Concrete runway 33 at Kennedy Space Center, Fla.

Payload: Hubble Space Telescope (HST) Servicing Mission (SM) 1; IMAX Camera; IMAX Cargo Bay Camera (ICBC); Air Force Maui Optical Site (AMOS)

Extravehicular Activity (EVA) conducted by Story Musgrave, Jeffrey Hoffman, Thomas Akers, and Kathryn Thornton during five spacewalks for a total of 35 hours, 28 minutes. EVA 1, Musgrave and Hoffman, 7 hours, 54 minutes; Musgrave and Hoffman successfully changed out Hubble's rate sensing units and electronics control unit and eight fuse plugs. EVA 2, Akers and Thornton, 6 hours, 36 minutes; Akers and Thornton installed two new solar arrays and jettisoned one of Hubble's original solar arrays, which was bent. EVA 3, Musgrave and Hoffman, 6 hours, 47 minutes; Musgrave and Hoffman removed and stored the telescope's original wide-field/planetary camera and installed the replacement Wide-Field/Planetary Camera II and two new magnetometers. EVA 4, Akers and Thornton, 6 hours, 50 minutes; Akers and Thornton removed the telescope's high-speed photometer and installed the corrective optics space telescope axial replacement unit and a new computer coprocessor. EVA 5, Musgrave and Hoffman, 7 hours, 21 minutes; Musgrave and Hoffman replaced the telescope's solar array drive electronics and installed the Goddard high-resolution spectrograph redundancy kit and two Mylar covers over the original magnetometers to contain any contamination or debris that might come off the instrument and protect it from ultraviolet degradation.

**STS-60 Mission Facts — Discovery —
Feb. 3–11, 1994**

Commander: Charles F. Bolden Jr.

Pilot: Kenneth S. Reightler Jr.

Mission Specialist: Franklin R. Chang-Diaz

Mission Specialist: N. Jan Davis

Mission Specialist: Ronald M. Sega

Mission Specialist: Sergei K. Krikalev, Russian Space Agency

Mission Duration: 192 hours (8 days), 7 hours, 10 minutes, 13 seconds

Miles Traveled: Approximately 3,439,704 statute miles

Inclination: 57 degrees

Orbits of Earth: 131

Orbital Altitude: 190 nautical miles (219 statute miles)

Liftoff Weight: Approximately 4,508,352 pounds

Orbiter Weight at Liftoff: Approximately 245,278 pounds

Payload Weight Up: Approximately 28,674 pounds

Payload Weight Down: Approximately 28,499 pounds

Orbiter Weight at Landing: Approximately 214,944 pounds

Landed: Concrete runway 33 at Kennedy Space Center, Fla.

Payload: Wake Shield Facility (WSF) 1 and SPACEHAB 02. Getaway special bridge assembly experiments: Capillary Pumped Loop (CAPL); Orbital Debris Radar Calibration Spheres (ODERACS); University of Bremen Satellite (BREMSAT); G-514; G-071; and G-536; Shuttle Amateur Radio Experiment (SAREX) II; Auroral Photography Experiment (APE-B)

**STS-62 Mission Facts — Columbia —
March 4–18, 1994**

Commander: John H. Casper

Pilot: Andrew M. Allen

Mission Specialist: Pierre J. Thuot

Mission Specialist: Charles D. "Sam" Gemar

Mission Specialist: Marsha S. Ivins

Mission Duration: 312 hours (13 days), 23 hours, 17 minutes, 28 seconds

Miles Traveled: Approximately 5,820,146 statute miles

Inclination: 39 degrees

Orbits of Earth: 224

Orbital Altitude: 160 nautical miles (184 statute miles)

Liftoff Weight: Approximately 4,519,308 pounds

Orbiter Weight at Liftoff: Approximately 256,086 pounds

Payload Weight Up: Approximately 19,556 pounds

STS-62 Mission Facts (Cont)

Payload Weight Down: Approximately 19,556 pounds

Orbiter Weight at Landing: Approximately
226,742 pounds

Landed: Concrete runway 33 at Kennedy Space Center,
Fla.

Payload: United States Microgravity Payload (USMP) 2; Office of Aeronautics and Space Technology (OAST) 2; Dexterous End Effector (DEE); Shuttle Solar Backscatter Ultraviolet/A (SSBUV/A); Limited-Duration Space Environment Candidate Material Exposure (LDCE); Advanced Protein Crystal Growth (APCG); Physiological Systems Experiment (PSE); Commercial Protein Crystal Growth (CPCG); Commercial Generic Bioprocessing Apparatus (CGBA); Auroral Photography Experiment Phase B (APE-B); Middeck Zero-Gravity Dynamics Experiment (MODE); Air Force Maui Optical Site (AMOS) Calibration Test; Bioreactor Demonstration System A

STS-59 Mission Facts — Endeavour — April 9–20, 1994

Commander: Sidney M. Gutierrez

Pilot: Kevin P. Chilton

Payload Commander: Linda M. Godwin

Mission Specialist: Jay Apt

Mission Specialist: Michael R. "Rich" Clifford

Mission Specialist: Thomas D. Jones

Mission Duration: 264 hours (11 days), 5 hours,
49 minutes, 30 seconds

Miles Traveled: Approximately 4,704,835 statute miles

Inclination: 57 degrees

Orbits of Earth: 183

Orbital Altitude: 120 nautical miles (138 statute miles)

Liftoff Weight: Approximately 4,510,987 pounds

Orbiter Weight at Liftoff: Approximately
246,575 pounds

Payload Weight Up: Approximately 27,536 pounds

Payload Weight Down: Approximately 27,536 pounds

Orbiter Weight at Landing: Approximately
221,713 pounds

Landed: Concrete runway 22 at Edwards Air Force
Base, Calif.

Payload: Space Radar Laboratory (SRL) 1; Consortium for Materials Development in Space Complex Autonomous Payload (CONCAP) IV; three getaway special (GAS) payloads; Space Tissue Loss (STL) A, B; Visual Function Tester (VFT) 4; Shuttle Amateur Radio Experiment (SAREX) II

**STS-65 Mission Facts — Columbia —
July 8–23, 1994**

Commander: Robert D. Cabana

Pilot: James D. Halsell Jr.

Payload Commander: Richard J. Hieb

Mission Specialist: Carl E. Walz

Mission Specialist: Leroy Chiao

Mission Specialist: Donald A. Thomas

Payload Specialist: Chiaki Mukai, Japan

Mission Duration: 336 hours (14 days), 17 hours,
56 minutes

Miles Traveled: Approximately 6,100,000 statute miles

Inclination: 28.45 degrees

Orbits of Earth: 236

Orbital Altitude: 160 nautical miles (184 statute miles)

Liftoff Weight: Approximately 4,522,475 pounds

Orbiter Weight at Liftoff: Approximately
258,333 pounds

Payload Weight Up: Approximately 23,836 pounds

Payload Weight Down: Approximately 23,836 pounds

Orbiter Weight at Landing: Approximately
229,522 pounds

Landed: Concrete runway 33 at Kennedy Space Center,
Fla.

Payload: International Microgravity Laboratory (IML) 2;
Orbital Acceleration Research Experiment (OARE);
Commercial Protein Crystal Growth (CPCG); Air
Force Maui Optical Site (AMOS); Military Appli-
cations of Ship Tracks (MAST); Shuttle Amateur
Radio Experiment (SAREX)

**STS-64 Mission Facts — Discovery —
Sept. 9–20, 1994**

Commander: Richard N. Richards

Pilot: L. Blaine Hammond Jr.

Mission Specialist: Carl J. Meade

Mission Specialist: Mark C. Lee

Mission Specialist: Susan J. Helms

Mission Specialist: Jerry M. Linenger

Mission Duration: 240 hours (10 days), 22 hours,
49 minutes, 57 seconds

Miles Traveled: Approximately 4,576,174 statute miles

Inclination: 57 degrees

Orbits of Earth: 177

Orbital Altitude: 140 nautical miles (161 statute miles)

Liftoff Weight: Approximately 4,504,154 pounds

Orbiter Weight at Liftoff: Approximately
242,768 pounds

Payload Weight Up: Approximately 20,417 pounds

STS-64 Mission Facts (Cont)

Payload Weight Down: Approximately 20,375 pounds

Orbiter Weight at Landing: Approximately 212,056 pounds

Landed: Concrete runway 04 at Edwards Air Force Base, Calif.

Payload: Lidar In-Space Technology Experiment (LITE); Shuttle Pointed Autonomous Research Tool for Astronomy (SPARTAN) 201-II; Robot-Operated Materials Processing System (ROMPS); Shuttle Plume Impingement Flight Experiment (SPIFEX); getaway special (GAS) bridge assembly with 10 GAS experiments; Trajectory Control Sensor (TCS); Simplified Aid for EVA Rescue (SAFER); Solid Surface Combustion Experiment (SSCE); Biological Research in Canisters (BRIC) III; Radiation Monitoring Experiment (RME) III; Military Applications of Ship Tracks (MAST); Shuttle Amateur Radio Experiment (SAREX) II; Air Force Maui Optical Site (AMOS) Calibration Test

Extravehicular Activity (EVA) conducted by Mark C. Lee and Carl J. Meade, 6 hours, 51 minutes. Lee and Meade tested the Simplified Aid for EVA Rescue (SAFER), a small, self-contained propulsive backpack device that provides free-flying mobility for an EVA astronaut in an emergency. They also evaluated several tools and an electronic cuff checklist that allows crew members greater and easier access to information away from the spacecraft.

STS-68 Mission Facts — Endeavour — Sept. 30–Oct. 11, 1994

Commander: Michael A. Baker

Pilot: Terrence W. Wilcutt

Payload Commander: Thomas David Jones

Mission Specialist: Steven L. Smith

Mission Specialist: Peter J.K. "Jeff" Wisoff

Mission Specialist: Daniel W. Bursch

Mission Duration: 264 hours (11 days), 5 hours, 47 minutes, 8 seconds

Miles Traveled: Approximately 4,703,000 statute miles

Inclination: 57 degrees

Orbits of Earth: 183

Orbital Altitude: 120 nautical miles (138 statute miles)

Liftoff Weight: Approximately 4,510,392 pounds

Orbiter Weight at Liftoff: Approximately 247,129 pounds

Payload Weight Up: Approximately 27,582 pounds

Payload Weight Down: Approximately 27,582 pounds

Orbiter Weight at Landing: Approximately 222,026 pounds

STS-68 Mission Facts (Cont)

Landed: Concrete runway 22 at Edwards Air Force Base, Calif.

Payload: Space Radar Laboratory (SRL) 2; five getaway special payloads; Chromosome and Plant Cell Division in Space (CHROMEX) 5; Biological Research in Canisters (BRIC) 01; Cosmic Radiation Effects and Activation Monitor (CREAM); Military Application of Ship Tracks (MAST); Commercial Protein Crystal Growth (CPCG)

STS-66 Mission Facts — Atlantis — Nov. 3–14, 1994

Commander: Donald R. McMonagle

Pilot: Curtis L. Brown Jr.

Payload Commander: Ellen Ochoa

Mission Specialist: Scott E. Parazynski

Mission Specialist: Joseph R. Tanner

Mission Specialist: Jean-Francois Clervoy, European Space Agency

Mission Duration: 240 hours (10 days), 22 hours, 34 minutes, 51 seconds

Miles Traveled: Approximately 4,554,791 statute miles

Inclination: 57 degrees

Orbits of Earth: 174

Orbital Altitude: 164 nautical miles (189 statute miles)

Liftoff Weight: Approximately 4,508,369 pounds

Orbiter Weight at Liftoff: Approximately 243,839 pounds

Payload Weight Up: Approximately 23,247 pounds

Payload Weight Down: Approximately 23,247 pounds

Orbiter Weight at Landing: Approximately 209,842 pounds

Landed: Concrete runway 22 at Edwards Air Force Base, Calif.

Payload: Atmospheric Laboratory for Applications and Science (ATLAS) 3; Cryogenic Infrared Spectrometers and Telescopes for the Atmosphere (CRISTA)-Shuttle Pallet Satellite (SPAS) 1; Experiment of the Sun for Complementing the ATLAS Payload for Education (ESCAPE) II; Inter-Mars Tissue Equivalent Proportional Counter (ITEPC); Shuttle Solar Backscatter Ultraviolet (SSBUV) A; Physiological and Anatomical Rodent Experiment (PARE/NIH-R); Protein Crystal Growth (PCG-TES and PCG-STES); Space Tissue Loss (STL/NIH-C-A); Shuttle Acceleration Measurement System (SAMS); Heat Pipe Performance (HPP)

**STS-63 Mission Facts — Discovery —
Feb. 3–11, 1995**

Commander: James D. Wetherbee

Pilot: Eileen Marie Collins

Mission Specialist: C. Michael Foale

Mission Specialist: Janice E. Voss

Mission Specialist: Bernard A. Harris Jr.

Mission Specialist: Vladimir Titov, Russian Space
Agency

Mission Duration: 192 hours (8 days), 6 hours,
29 minutes, 35 seconds

Miles Traveled: Approximately 2,992,806 statute miles

Inclination: 51.6 degrees

Orbits of Earth: 130

Orbital Altitude: 170-213 nautical miles
(196-245 statute miles)

Liftoff Weight: Approximately 4,511,481 pounds

Orbiter Weight at Liftoff: Approximately 247,476 pounds

Payload Weight Up: Approximately 19,051 pounds

Payload Weight Down: Approximately 18,994 pounds

Orbiter Weight at Landing: Approximately
211,278 pounds

Landed: Concrete runway 15 at Kennedy Space Center,
Fla.

Payload: SPACEHAB 03; Shuttle Pointed Autonomous
Research Tool for Astronomy (SPARTAN) 204;
Cryo Systems Experiment (CSE)/GLO-2 Experi-
ment Payload (CGP)/Orbital Debris Radar Calibra-
tion Spheres (ODERACS) 2; Solid Surface Com-
bustion Experiment (SSCE); Air Force Maui Optical
Site (AMOS); IMAX Cargo Bay Camera (ICBC)

Extravehicular Activity (EVA) conducted by Bernard
Harris and Michael Foale, 4 hours, 39 minutes.
Harris and Foale evaluated spacesuit modifica-
tions that would provide astronauts with better
thermal protection from cold and practiced han-
dling large objects in space in order to increase
NASA's experience base as it prepares for the on-
orbit assembly of the International Space Station.
The EVA was terminated prematurely when Harris
and Foale reported they were getting too cold.

Of Note: Discovery rendezvoused with Russia's space
station, Mir, to a distance of 37 feet and performed
a fly-around.

**STS-67 Mission Facts — Endeavour —
March 2–18, 1995**

Commander: Stephen S. Oswald

Pilot: William G. Gregory

Payload Commander: Tamara E. Jernigan

Mission Specialist: John M. Grunsfeld

Mission Specialist: Wendy B. Lawrence

STS-67 Mission Facts (Cont)

Payload Specialist: Ronald A. Parise

Payload Specialist: Samuel T. Durrance

Mission Duration: 384 hours (16 days), 15 hours, 9 minutes, 46 seconds

Miles Traveled: Approximately 6,900,000 statute miles

Inclination: 28.45 degrees

Orbits of Earth: 263

Orbital Altitude: 190 nautical miles (219 statute miles)

Liftoff Weight: Approximately 4,520,785 pounds

Orbiter Weight at Liftoff: Approximately 256,293 pounds

Payload Weight Up: Approximately 28,916 pounds

Payload Weight Down: Approximately 28,916 pounds

Orbiter Weight at Landing: Approximately 217,989 pounds

Landed: Concrete runway 22 at Edwards Air Force Base, Calif.

Payload: Ultraviolet Astronomy (ASTRO) 2; Middeck Active Control Experiment (MACE); Protein Crystal Growth—Thermal Enclosure System (PCG-TES) 03; Protein Crystal Growth—Single-Locker Thermal Enclosure System (PCG-STES) 02; Commercial Materials Dispersion Apparatus Minilab/Instrumentation Technology Associates, Inc. Experiments (CMIX) 03; Shuttle Amateur Radio Experiment (SAREX) II; two getaway special experiments

STS-71 Mission Facts — Atlantis — June 27–July 7, 1995

Commander: Robert L. “Hoot” Gibson

Pilot: Charles J. Precourt Jr.

Mission Specialist: Ellen S. Baker

Mission Specialist: Gregory J. Harbaugh

Mission Specialist: Bonnie J. Dunbar

Mir-19 Crew Member: Anatoly Solovyez (Russia)—
up only

Mir-19 Crew Member: Nikolai Budarin (Russia)—
up only

Mir-18 Crew Member: Vladimir Dezhurov (Russia)—
down only

Mir-18 Crew Member: Gennadiy Strekalov (Russia)—
down only

Mir-18 Crew Member: Norman E. Thagard (U.S.)—
down only

Mission Duration: 216 hours (9 days), 19 hours, 23 minutes, 8 seconds

Miles Traveled: Approximately 4,100,000 statute miles

Inclination: 51.6 degrees

Orbits of Earth: 154

Orbital Altitude: 213 nautical miles (245 statute miles)

STS-71 Mission Facts (Cont)

Liftoff Weight: Approximately 4,511,483 pounds

Orbiter Weight at Liftoff: Approximately 248,417 pounds

Payload Weight Up: Approximately 26,878 pounds

Payload Weight Down: Approximately 27,410 pounds

Orbiter Weight at Landing: Approximately
214,709 pounds

Landed: Concrete runway 15 at Kennedy Space Center,
Fla.

Payload: Shuttle/Mir Mission 1; Spacelab-Mir; IMAX
camera; Shuttle Amateur Radio Experiment
(SAREX)

STS-70 Mission Facts — Discovery — July 13–22, 1995

Commander: Terrence T. Henricks

Pilot: Kevin R. Kregel

Mission Specialist: Nancy J. Currie

Mission Specialist: Donald A. Thomas

Mission Specialist: Mary Ellen Weber

Mission Duration: 192 hours (8 days), 22 hours,
20 minutes, 5 seconds

Miles Traveled: Approximately 3,700,000 statute miles

Inclination: 28.45 degrees

Orbits of Earth: 142

Orbital Altitude: 160 nautical miles (184 statute miles)

Liftoff Weight: Approximately 4,521,772 pounds

Orbiter Weight at Liftoff: Approximately 258,584
pounds

Payload Weight Up: Approximately 44,445 pounds

Payload Weight Down: Approximately 6,671 pounds

Orbiter Weight at Landing: Approximately
194,911 pounds

Landed: Concrete runway 33 at Kennedy Space Center,
Fla.

Payload: Tracking and Data Relay Satellite (TDRS) G/
Inertial Upper Stage (IUS); Bioreactor Demonstration
System (BDS) B; Biological Research in Can-
isters (BRIC); Commercial Protein Crystal Growth
(CPCG); Hand-Held, Earth-Oriented, Real-Time,
Cooperative, User-Friendly, Location-Targeting
and Environmental System (HERCULES); Micro-
capsules in Space (MIS) B; Physiological and
Anatomical Rodent Experiment (PARE)/National
Institutes of Health (NIH) Rodents (R); Radiation
Monitoring Experiment (RME) III; Shuttle Amateur
Radio Experiment (SAREX) II; Space Tissue Loss
(STL)/National Institutes of Health (NIH) Cells (C);
Military Applications of Ship Tracks (MAST); Visual
Function Tester (VFT) 4; Window Experiment
(WINDEX)

**STS-69 Mission Facts — Endeavour —
Sept. 7–18, 1995**

Commander: David M. Walker

Pilot: Kenneth D. Cockrell

Payload Commander: James S. Voss

Mission Specialist: James H. Newman

Mission Specialist: Michael L. Gernhardt

Mission Duration: 240 hours (10 days), 20 hours,
29 minutes, 52 seconds

Miles Traveled: Approximately 4,500,000 statute miles

Inclination: 28.45 degrees

Orbits of Earth: 171

Orbital Altitude: 200 nautical miles (230 statute miles)

Liftoff Weight: Approximately 4,520,139 pounds

Orbiter Weight at Liftoff: Approximately
256,808 pounds

Payload Weight Up: Approximately 25,352 pounds

Payload Weight Down: Approximately 25,304 pounds

Orbiter Weight at Landing: Approximately
219,887 pounds

Landed: Concrete runway 33 at Kennedy Space Center,
Fla.

Payload: Wake Shield Facility (WSF) 2; Shuttle
Pointed Autonomous Research Tool for Astronomy
(SPARTAN) 201; International Extreme Ultraviolet
Hitchhiker (IEH)1; Inter-Mars Tissue Equivalent
Proportional Counter (ITEPC); Extravehicular Activ-
ity Development Flight Test (EDFT) 2; Capillary
Pumped Loop (CAPL) 2/getaway special (GAS)
bridge assembly with five GAS payloads; Auroral
Photography Experiment (APE) B; Biological Re-
search in Canisters (BRIC); Commercial Generic
Bioprocessing Apparatus (CGBA), Configuration
A; Electrolysis Performance Improvement Concept
Study (EPICS); Space Tissue Loss (STL)/National
Institutes of Health (NIH)—Cells (C); Commercial
Middeck Instrumentation Technology Associates
Experiment (CMIX)

Extravehicular Activity (EVA) conducted by James
Voss and Michael Gernhardt, 6 hours, 45 minutes.
Voss and Gernhardt performed a number of tasks
designed to evaluate and verify specific assembly
and maintenance techniques and tools for the
International Space Station. They also evaluated
spacesuit design modifications to protect space-
walkers from the extremely cold space environ-
ment as well as an electronic cuff checklist device
worn on the wrist.

STS-73 Mission Facts — Columbia —
Oct. 20–Nov. 5, 1995

Commander: Kenneth D. Bowersox
Pilot: Kent V. Rominger
Payload Commander: Kathryn C. Thornton
Mission Specialist: Catherine G. “Cady” Coleman
Mission Specialist: Michael E. Lopez-Alegria
Payload Specialist: Fred W. Leslie
Payload Specialist: Albert Sacco Jr.
Mission Duration: 360 hours (15 days), 21 hours,
53 minutes, 16 seconds
Miles Traveled: Approximately 6.6 million statute miles
Inclination: 39 degrees
Orbits of Earth: 256
Orbital Altitude: 150 nautical miles (173 statute miles)
Liftoff Weight: Approximately 4,521,539 pounds
Orbiter Weight at Liftoff: Approximately 257,162 pounds
Payload Weight Up: Approximately 33,622 pounds
Payload Weight Down: Approximately 33,622 pounds
Orbiter Weight at Landing: Approximately
230,164 pounds
Landed: Concrete runway 33 at Kennedy Space Center,
Fla.
Payload: United States Microgravity Laboratory (USML)
2; Orbital Acceleration Research Experiment
(OARE)

STS-74 Mission Facts — Atlantis —
Nov. 12–20, 1995

Commander: Kenneth D. Cameron
Pilot: James D. Halsell Jr.
Mission Specialist 1: Chris A. Hadfield, Canadian
Space Agency
Mission Specialist 2: Jerry L. Ross
Mission Specialist 3: William S. McArthur Jr.
Mir 20 Crew Members (Aboard Mir):
Commander: Yuri Gidzenko, Russian Space Agency
Flight Engineer: Sergei Avdeyev, Russian Space
Agency
Cosmonaut-Researcher: Thomas Reiter, European
Space Agency
Mission Duration: 192 hours (8 days), 4 hours,
31 minutes, 42 seconds
Miles Traveled: Approximately 3.4 million statute miles
Inclination: 51.6 degrees
Orbits of Earth: 129
Orbital Altitude: 213 nautical miles (245 statute miles)
Liftoff Weight: Approximately 4,511,797 pounds
Orbiter Weight at Liftoff: Approximately 247,709 pounds
Payload Weight Up: Approximately 13,525 pounds

STS-74 Mission Facts (Cont)

Payload Weight Down: Approximately 3,938 pounds

Orbiter Weight at Landing: Approximately
204,375 pounds

Landed: Concrete runway 33 at Kennedy Space Center,
Fla.

Payload: Shuttle-Mir Mission 2; docking module with
two attached solar arrays; IMAX Cargo Bay Cam-
era (ICBC); Glow Experiment (GLO-4)/ Photogram-
metric Appendage Structural Dynamics Experi-
ment (PASDE) Payload (GPP); Shuttle Amateur
Radio Experiment (SAREX) II

STS-72 Mission Facts — Endeavour — Jan. 11–20, 1996

Commander: Brian K. Duffy

Pilot: Brent W. Jett Jr.

Mission Specialist 1: Leroy Chiao

Mission Specialist 2: Winston E. Scott

Mission Specialist 3: Koichi Wakata, National Space
Development Agency of Japan

Mission Specialist 4: Daniel T. Barry

Mission Duration: 192 hours (8 days), 22 hours,
1 minute, 47 seconds

Miles Traveled: Approximately 3.7 million statute miles

Inclination: 28.45 degrees

Orbits of Earth: 142

Orbital Altitude: 250 nautical miles (288 statute miles)

Liftoff Weight: Approximately 4,514,955 pounds

Orbiter Weight at Liftoff: Approximately 247,319 pounds

Payload Weight Up: Approximately 14,353 pounds

Payload Weight Down: Approximately 22,233 pounds

Orbiter Weight at Landing: Approximately
217,269 pounds

Landed: Concrete runway 15 at Kennedy Space Center,
Fla.

Payload: Space Flyer Unit (SFU) retrieval; Office of
Aeronautics and Space Technology (OAST) Flyer;
Shuttle Solar Backscatter Ultraviolet (SSBUV/A);
Shuttle Laser Altimeter (SLA) 01/Getaway Special
(GAS)(5); Extravehicular Activity Development
Flight Test (EDFT) 03; Physiological and Anatomical
Rodent Experiment (PARE)/National Institutes
of Health (NIH) Rodents (R) 03; Protein Crystal
Growth (PCG) Single-Locker Thermal Enclosure
System (STES) 04; Commercial Protein Crystal
Growth (CPCG) 08; Space Tissue Loss (STL)/
National Institutes of Health (NIH) Cells (C) 05

STS-72 Mission Facts (Cont)

Extravehicular Activity (EVA) conducted by Leroy Chiao, Daniel Barry, and Winston Scott during two spacewalks for a total of 13 hours, 2 minutes. EVA 1, Chiao and Barry, 6 hours, 9 minutes; Chiao and Barry evaluated a new EVA workstation, a movable stanchion that provides stability for astronauts and holders for tools, a flexible foot restraint, and a rigid umbilical that may be used on the International Space Station to hold fluid and electrical umbilicals in place. EVA 2, Chiao and Scott, 6 hours, 53 minutes; Chiao and Scott evaluated a utility box designed to hold avionics and fluid line connections on the space station, an on-orbit-installed slidewire to which tethers can be connected, thermal improvements of space suits, and a wrist-mounted computer called the electronic cuff checklist. They also took measurements of the forces induced by work.

STS-75 Mission Facts — Columbia — Feb. 22–March 9, 1996

Commander: Andrew M. Allen

Pilot: Scott J. “Doc” Horowitz

Payload Commander: Franklin R. Chang-Diaz

Mission Specialist 1: Jeffrey A. Hoffman

Mission Specialist 2: Maurizio Cheli, European Space Agency

Mission Specialist 3: Claude Nicollier, European Space Agency

Payload Specialist: Umberto Guidoni, Italian Space Agency

Mission Duration: 360 hours (15 days), 17 hours, 40 minutes, 21 seconds

Miles Traveled: Approximately 6.5 million statute miles

Inclination: 28.45 degrees

Orbits of Earth: 252

Orbital Altitude: 160 nautical miles (184 statute miles)

Liftoff Weight: Approximately 4,526,493 pounds

Orbiter Weight at Liftoff: Approximately 261,491 pounds

Payload Weight Up: Approximately 23,353 pounds

Payload Weight Down: 23,263 pounds

Orbiter Weight at Landing: 228,571 pounds

Landed: Concrete runway 33 at Kennedy Space Center, Fla.

Payload: Tethered Satellite System (TSS) Reflight (1R); Orbital Acceleration Research Experiment (OARE) (part of United States Microgravity Payload 3); USMP-3; Commercial Protein Crystal Growth (CPCG) 09, Block IV; Middeck Glovebox Experiment (MGBX) (part of USMP-3)

Of Note: During the deployment of TSS, the tether broke and the satellite was lost.

**STS-76 Mission Facts — Atlantis —
March 22–31, 1996**

Commander: Kevin P. Chilton

Pilot: Richard A. Searfoss

Mission Specialist: Shannon W. Lucid—up only

Mission Specialist: Linda M. Godwin

Mission Specialist: Michael R. “Rich” Clifford

Mission Specialist: Ronald M. Sega

Mission Duration: 216 hours (9 days), 5 hours,
16 minutes, 48 seconds

Miles Traveled: Approximately 3.8 million statute miles

Inclination: 51.6 degrees

Orbits of Earth: 145

Orbital Altitude: 213 nautical miles (245 statute miles)

Liftoff Weight: Approximately 4,509,503 pounds

Orbiter Weight at Liftoff: Approximately
246,345 pounds

Payload Weight Up: Approximately 14,888 pounds

Payload Weight Down: Approximately 12,058 pounds

Orbiter Weight at Landing: Approximately
210,316 pounds

Landed: Concrete runway 22 at Edwards Air Force
Base, Calif.

Payload: Shuttle-Mir Mission 3; SPACEHAB/Mir 03; Kid-Sat; Shuttle Amateur Radio Experiment (SAREX) II, Configuration M; RME 1304—Mir/Environmental Effects Payload (MEEP); orbiter docking system; RME 1315—Trapped Ions in Space Experiment (TRIS); Extravehicular Activity Development Flight Test (EDFT) 04

Extravehicular Activity (EVA) conducted by Linda Godwin and Rich Clifford, 6 hours, 2 minutes. Godwin and Clifford attached four experiments, known collectively as MEEP, onto handrails located on Mir’s docking module. They also detached a television camera from the outside of the Mir docking module to return it to Earth, and evaluated a variety of new spacewalking tools capable of being used on both the U.S. and Russian spacecraft.

**STS-77 Mission Facts — Endeavour —
May 19–29, 1996**

Commander: John H. Casper

Pilot: Curtis L. Brown Jr.

Mission Specialist: Daniel W. Bursch

Mission Specialist: Andrew S.W. Thomas

Mission Specialist: Marc Garneau, Canadian Space
Agency

Mission Specialist: Mario Runco Jr.

Mission Duration: 240 hours (10 days), 0 hours,
40 minutes, 10 seconds

STS-77 Mission Facts (Cont)

Miles Traveled: Approximately 4.1 million statute miles

Inclination: 39 degrees

Orbits of Earth: 161

Orbital Altitude: 153 nautical miles (176 statute miles)

Liftoff Weight: Approximately 4,518,947 pounds

Orbiter Weight at Liftoff: Approximately
254,538 pounds

Payload Weight Up: Approximately 26,971 pounds

Payload Weight Down: Approximately 26,149 pounds

Orbiter Weight at Landing: Approximately
221,382 pounds

Landed: Concrete runway 33 at Kennedy Space Center,
Fla.

Payload: Shuttle Pointed Research Tool for Astronomy (SPARTAN) 207/Inflatable Antenna Experiment (IAE); Technology Experiments Advancing Missions in Space (TEAMS) 01 (includes Vented Tank Resupply Experiment [VTRE], Global Positioning System [GPS] Attitude and Navigation Experiment [GANE] [RME 1316], Liquid Metal Test Experiment [LMTE], and Passive Aerodynamically Stabilized Magnetically Damped Satellite [PAMS] Satellite Test Unit [STU]; SPACEHAB-4; Brilliant Eyes Ten-Kelvin Sorption Cryocooler Experiment (BETSCE); 12 getaway specials attached to a GAS bridge assembly (GAS 056, 063, 142, 144, 163, 200, 490, 564, 565, 703, 741 and the Reduced-Fill Tank Pressure Control Experiment [RFTPCE]; Aquatic Research Facility (ARF) 01; Biological Research in Canisters (BRIC) 07, Block III

STS-78 Mission Facts – Columbia

June 20–July 7, 1996

Commander: Terence T. “Tom” Henricks

Pilot: Kevin R. Kregel

Mission Specialist: Susan J. Helms

Mission Specialist: Richard M. Linnehan

Mission Specialist: Charles E. Brady Jr.

Payload Specialist: Jean-Jacques Favier, French Atomic Energy Commission (CEA), French Space Agency (CNES)

Payload Specialist: Robert Brent Thirsk, Canadian Space Agency

Mission Duration: 384 hours (16 days), 21 hours,
48 minutes, 30 seconds

Miles Traveled: Approximately 7 million statute miles

Inclination: 39 degrees

Orbits of Earth: 272

Orbital Altitude: 150 nautical miles (173 statute miles)

Liftoff Weight: Approximately 4,517,981 pounds

STS-78 Mission Facts (Cont)

Orbiter Weight at Liftoff: Approximately 254,823 pounds

Payload Weight Up: Approximately 23,537 pounds

Payload Weight Down: Approximately 23,537 pounds

Orbiter Weight at Landing: Approximately 228,009 pounds

Landed: Concrete runway 33 at Kennedy Space Center, Fla.

Payload: Life and Microgravity Sciences (LMS) 01 Spacelab with long crew transfer tunnel; Orbital Acceleration Research Experiment (OARE); extended-duration orbiter cryogenic pallet; Biological Research in Canisters (BRIC) 8, Block II; Shuttle Amateur Radio Experiment (SAREX) II, Configuration C

STS-79 Mission Facts – Atlantis – Sept. 16–26, 1996

Commander: William F. Readdy

Pilot: Terrence W. Wilcutt

Mission Specialist: Thomas D. Akers

Mission Specialist: Jerome Apt

Mission Specialist: Carl E. Walz

Mission Specialist: John E. Blaha—up only

Mir Crew Member: Shannon W. Lucid—down only

Mission Duration: 240 hours (10 days), 3 hours, 18 minutes, 24 seconds

Miles Traveled: Approximately 3.9 million statute miles

Inclination: 51.6 degrees

Orbits of Earth: 160

Orbital Altitude: 213 nautical miles (245 statute miles)

Liftoff Weight: Approximately 4,510,356 pounds

Orbiter Weight at Liftoff: Approximately 249,327 pounds

Payload Weight Up: Approximately 19,516 pounds

Payload Weight Down: Approximately 18,346 pounds

Orbiter Weight at Landing: Approximately 215,176 pounds

Landed: Concrete runway 15 at Kennedy Space Center, Fla.

Payload: Shuttle/Mir Mission 04; SPACEHAB/Mir 05; orbiter docking system; Shuttle/Mir Mission 04 middeck science; Shuttle Amateur Radio Experiment (SAREX) II, configuration M; IMAX in-cabin camera; Midcourse Space Experiment (MSX)

**STS-80 Mission Facts – Columbia –
Nov. 19–Dec. 7, 1996**

Commander: Kenneth D. Cockrell

Pilot: Kent V. Rominger

Mission Specialist: Tamara E. Jernigan

Mission Specialist: Thomas David Jones

Mission Specialist: F. Story Musgrave

Mission Duration: 408 hours (17 days), 15 hours,
54 minutes, 28 seconds

Miles Traveled: Approximately 7.6 million statute miles

Inclination: 28.45 degrees

Orbits of Earth: 279

Orbital Altitude: 190 nautical miles (219 statute miles)

Liftoff Weight: Approximately 4,525,340 pounds

Orbiter Weight at Liftoff: Approximately
261,910 pounds

Payload Weight Up: Approximately 21,489 pounds

Payload Weight Down: Approximately 21,387 pounds

Orbiter Weight at Landing: Approximately
227,879 pounds

Landed: Concrete runway 33 at Kennedy Space Center,
Fla.

Payload: Wake Shield Facility (WSF) 03; Orbiting and
Retrievable Far and Extreme Ultraviolet Spectro-
graph—Shuttle Pallet Satellite (ORFEUS-SPAS) II;
Inter-Mars Tissue Equivalent Proportional Counter
(ITEPC) (also known as DSO 485); Extravehicular
Activity Development Flight Test (EDFT) 05; Space
Experiment Module (SEM) 01/Getaway Special
(GAS); Physiological and Anatomical Rodent
Experiment (PARE)/National Institutes of Health
(NIH)-Rodents (R) 04; Commercial Materials
Dispersions Apparatus (MDA) Instrumentation
Technology Associates (ITA) Experiments (CMIX)
05, Configuration B; Visualization in an Experimen-
tal Water Capillary Pumped Loop (VIEW-CPL); Cell
Culture Module (CCM), Configuration A; Biological
Research in Canisters (BRIC) 09, Block 1; Mid-
course Space Experiment (payload of opportunity)

Of Note: Because of problems in opening Columbia's
airlock hatch, EDFT 05 could not be performed,
and no extravehicular activity occurred.

**STS-81 Mission Facts – Atlantis –
Jan. 12–22, 1997**

Commander: Michael A. Baker

Pilot: Brent W. Jett Jr.

Mission Specialist: John M. Grunsfeld

Mission Specialist: Marsha S. Ivins

Mission Specialist: Peter J.K. "Jeff" Wisoff

Mission Specialist: Jerry M. Linenger—up only

Mir Crew Member: John E. Blaha—down only

STS-81 Mission Facts (Cont)

Mission Duration: 240 hours (10 days), 4 hours, 56 minutes, 31 seconds

Miles Traveled: Approximately 3.8 million statute miles

Inclination: 51.6 degrees

Orbits of Earth: 161

Orbital Altitude: 213 nautical miles (245 statute miles)

Liftoff Weight: Approximately 4,510,780 pounds

Orbiter Weight at Liftoff: Approximately 249,936 pounds

Payload Weight Up: Approximately 19,321 pounds

Payload Weight Down: Approximately 18,144 pounds

Orbiter Weight at Landing: Approximately 214,452 pounds

Landed: Concrete runway 33 at Kennedy Space Center, Fla.

Payload: SPACEHAB 06 double module; orbiter docking system; Shuttle/Mir Mission 05 middeck science, Midcourse Space Experiment (MSX); Cosmic Radiation Effects and Activation Monitor (CREAM); KidSat

STS-82 Mission Facts – Discovery – Feb. 11–21, 1997

Commander: Kenneth D. Bowersox

Pilot: Scott J. “Doc” Horowitz

Mission Specialist: Mark C. Lee

Mission Specialist: Gregory J. Harbaugh

Mission Specialist: Steven L. Smith

Mission Specialist: Joseph R. Tanner

Mission Specialist: Steven A. Hawley

Mission Duration: 216 hours (9 days), 23 hours, 38 minutes, 9 seconds

Miles Traveled: Approximately 4.1 million statute miles

Inclination: 28.45 degrees

Orbits of Earth: 150

Orbital Altitude: 320 nautical miles (369 statute miles)

Liftoff Weight: Approximately 4,514,520 pounds

Orbiter Weight at Liftoff: Approximately 251,371 pounds

Payload Weight Up: Approximately 16,735 pounds

Payload Weight Down: Approximately 16,429 pounds

Orbiter Weight at Landing: Approximately 214,014 pounds

Landed: Concrete runway 15 at Kennedy Space Center, Fla.

Payload: Hubble Space Telescope Servicing Mission 02 (second axial carrier, orbital replacement unit carrier, flight support system); Midcourse Space Experiment

STS-82 Mission Facts (Cont)

Extravehicular Activity (EVA) conducted by Mark Lee, Steven Smith, Gregory Harbaugh, and Joseph Tanner during five spacewalks for a total of 33 hours, 11 minutes. EVA 1, Lee and Smith, 6 hours, 42 minutes; Lee and Smith removed and replaced the Goddard high-resolution spectrograph and the faint-object spectrograph with the new space telescope imaging spectrograph and the near-infrared camera and multi-object spectrometer, respectively. EVA 2, Harbaugh and Tanner, 7 hours, 27 minutes; Harbaugh and Tanner replaced a degraded fine guidance sensor and a failed engineering and science tape recorder with new spares. They also installed a new unit known as the optical control electronics enhancement kit. EVA 3, Lee and Smith, 7 hours, 11 minutes; Lee and Smith removed and replaced a data interface unit and replaced an old reel-to-reel engineering and science tape recorder with a new digital solid-state recorder. They also changed out one of Hubble's four reaction wheel assembly units. EVA 4, Harbaugh and Tanner, 6 hours, 34 minutes; Harbaugh and Tanner replaced a solar array drive electronics package and covers over Hubble's magnetometers. They then placed thermal blankets of multilayer material over two areas of degraded insulation around the light shield portion of the telescope just below the top of the astronomical observatory. EVA 5, Lee and Smith, 5 hours, 17 minutes; Lee and Smith attached several thermal insulation blankets to three equipment compartments at the top of the support systems module section of Hubble. The compartments contain key data processing, electronics and scientific instrument telemetry packages. Over the course of the mission, Hubble was also reboosted into an orbit approximately 8 nautical miles higher.

STS-83 Mission Facts — Columbia — April 4–8, 1997

Commander: James D. Halsell Jr.

Pilot: Susan L. Still

Payload Commander: Janice Voss

Mission Specialist: Donald A. Thomas

Mission Specialist: Michael L. Gernhardt

Payload Specialist: Roger K. Crouch

Payload Specialist: Gregory T. Linteris

Mission Duration: 72 hours (3 days), 23 hours,
13 minutes, 38 seconds

Miles Traveled: Approximately 1.5 million statute miles

Inclination: 28.45 degrees

Orbits of Earth: 63

STS-83 Mission Facts (Cont)

Orbital Altitude: 160 nautical miles (184 statute miles)

Liftoff Weight: Approximately 4,523,076 pounds

Orbiter Weight at Liftoff: Approximately
259,927 pounds

Payload Weight Up: Approximately 25,530 pounds

Payload Weight Down: Approximately 25,530 pounds

Orbiter Weight at Landing: Approximately
213,060 pounds

Landed: Concrete runway 33 at Kennedy Space Center,
Fla.

Payload: Microgravity Science Laboratory (MSL) 01;
Spacelab module with long crew transfer tunnel;
extended-duration orbiter cryogenic pallet;
Cryogenic Flexible Diode Heat Pipe Experiment
(CRYOFD); Orbital Acceleration Research Experiment
(OARE); Protein Crystal Growth (PCG)—
Single-Locker Thermal Enclosure System (STES);
Shuttle Amateur Radio Experiment (SAREX) II;
Midcourse Space Experiment (MSX)

The mission was cut short by shuttle managers because of a problem with fuel cell No. 2, which displayed evidence of internal voltage degradation after the launch.

STS-84 Mission Facts — Atlantis — May 15–24, 1997

Commander: Charles J. Precourt

Pilot: Eileen Marie Collins

Mission Specialist: Jerry M. Linenger (down only)

Mission Specialist: C. Michael Foale (up only)

Mission Specialist: Elena V. Kondakova, RSC Energia

Mission Specialist: Carlos I. Noriega

Mission Specialist: Edward T. Lu

Mission Specialist: Jean-Francois Clervoy, European
Space Agency

Mission Duration: 216 hours (9 days), 5 hours,
20 minutes, 47 seconds

Miles Traveled: Approximately 3.6 million statute miles

Inclination: 51.6 degrees

Orbits of Earth: 144

Orbital Altitude: 213 nautical miles (245 statute miles)

Liftoff Weight: Approximately 4,509,832 pounds

Orbiter Weight at Liftoff: Approximately
249,624 pounds

Payload Weight Up: Approximately 19,779 pounds

Payload Weight Down: Approximately 19,387 pounds

Orbiter Weight at Landing: Approximately
213,865 pounds

Landed: Concrete runway 33 at Kennedy Space Center,
Fla.

STS-84 Mission Facts (Cont)

Payload: SPACEHAB 07 double module/Mir 06; transfer tunnel; transfer tunnel extension; orbiter docking system; European Space Agency proximity operations sensor (EPS); Shuttle/Mir Mission 06 middeck science; Cosmic Radiation Effects and Activation Monitor (CREAM); Radiation Monitoring Equipment (RME) III; Shuttle Ionospheric Modification With Pulsed Local Exhaust (SIMPLEX) Liquid Motion Experiment (LME); Protein Crystal Growth (PCG)—Single-Locker Thermal Enclosure System (STES); Midcourse Space Experiment (MSX); Electrolysis Performance Improvement Concept Study (EPICS)

STS-94 Mission Facts — Columbia — July 1–17, 1997

Commander: James D. Halsell Jr.

Pilot: Susan L. Still

Mission Specialist: Donald A. Thomas

Mission Specialist: Janice Voss

Mission Specialist: Michael L. Gernhardt

Payload Specialist: Gregory T. Linteris

Payload Specialist: Roger K. Crouch

Mission Duration: 360 hours (15 days), 16 hours,
45 minutes, 29 seconds

Miles Traveled: Approximately 6.2 million statute miles

Inclination: 28.45 degrees

Orbits of Earth: 251

Orbital Altitude: 160 nautical miles (184 statute miles)

Liftoff Weight: Approximately 4,523,389 pounds

Orbiter Weight at Liftoff: Approximately
260,266 pounds

Payload Weight Up: Approximately 25,568 pounds

Payload Weight Down: Approximately 25,568 pounds

Orbiter Weight at Landing: Approximately
230,292 pounds

Landed: Concrete runway 33 at Kennedy Space Center,
Fla.

Payload: First Microgravity Science Laboratory (MSL) 01; Spacelab module with long crew transfer tunnel; Extended-Duration Orbiter Cryogenic Pallet; Cryogenic Flexible Diode Heat Pipe Experiment (CRYOFD); Orbiter Acceleration Research Experiment (OARE); Protein Crystal Growth (PCG)—Single-Locker Thermal Enclosure System (STES); Shuttle Amateur Radio Experiment (SAREX) II; Midcourse Space Experiment (MSX)—payload of opportunity with no onboard hardware

**STS-85 Mission Facts — Discovery—
Aug. 7–19, 1997**

Commander: Curtis L. Brown Jr.

Pilot: Kent Rominger

Mission Specialist: N. Jan Davis

Mission Specialist: Robert L. Curbeam Jr.

Mission Specialist: Stephen K. Robinson

Payload Specialist: Bjarni Tryggvason, Canadian Space Agency

Mission Duration: 264 hours (11 days), 20 hours, 28 minutes, 7 seconds

Miles Traveled: Approximately 4.7 million statute miles

Inclination: 57 degrees

Orbits of Earth: 190

Orbital Altitude: 160 nautical miles (184 statute miles)

Liftoff Weight: Approximately 4,512,125 pounds

Orbiter Weight at Liftoff: Approximately 250,101 pounds

Payload Weight Up: Approximately 24,982 pounds

Payload Weight Down: Approximately 24,843 pounds

Orbiter Weight at Landing: Approximately 219,571 pounds

Landed: Concrete runway 33 at Kennedy Space Center, Fla.

Payload: Cryogenic Infrared Spectrometers and Telescopes for the Atmosphere (CRISTA)—Shuttle Pallet Satellite (SPAS) II; International Extreme Ultraviolet Hitchhiker (IEH) 02; Manipulator Flight Demonstration (MFD); Technology Applications and Science (TAS) 01; Getaway Specials 572 and 745; MFD aft flight deck equipment; Bioreactor Demonstration System (BDS) 03, Configuration B; Biological Research in Canisters (BRIC) 10; Shuttle Ionospheric Modification With Pulsed Local Exhaust (SIMPLEX); Protein Crystal Growth (PCG)—Single-Locker Thermal Enclosure System (STES) 05; Advanced X-Ray Astrophysics Facility—Imaging (AXAF) Charge Coupled Device (CCD) Imaging Spectrometer (ACIS); Midcourse Space Experiment (MSX)—payload of opportunity with no onboard hardware; Southwest Ultraviolet Imaging System (SWIS); Solid Surface Combustion Experiment (SSCE)

**STS-86 Mission Facts — Atlantis —
Sept. 25–Oct. 6, 1997**

Commander: James D. Wetherbee

Pilot: Michael J. Bloomfield

Mission Specialist: Vladimir Georgievich Titov, Russian Space Agency

Mission Specialist: Scott E. Parazynski

Mission Specialist: Jean-Loup J.M. Chretien, French Space Agency

STS-86 Mission Facts (Cont)

Mission Specialist: Wendy B. Lawrence

Mission Specialist: David A. Wolf—up only

Mission Specialist: C. Michael Foale—down only

Mission Duration: 240 hours (10 days), 19 hours,
22 minutes, 12 seconds

Miles Traveled: Approximately 4,225,000 statute miles

Inclination: 51.6 degrees

Orbits of Earth: 170

Orbital Altitude: 213 nautical miles (245 statute miles)

Liftoff Weight: Approximately 4,514,278 pounds

Orbiter Weight at Liftoff: Approximately 251,518 pounds

Payload Weight Up: Approximately 20,531 pounds

Payload Weight Down: Approximately 20,079 pounds

Orbit Weight at Landing: Approximately
213,979 pounds

Landed: Concrete runway 15 at Kennedy Space Center,
Fla.

Payload: SPACEHAB double module/Mir 07; transfer
tunnel; transfer tunnel extension; orbiter docking
system; RME1314: European Space Agency Prox-
imity Operations Sensor (EPS); Seeds in Space
(SEEDS) II; MEEP carriers; Shuttle/Mir Mission 07
middeck science; Cosmic Radiation Effects and
Activation Monitor (CREAM); KidSat; Commercial
Protein Crystal Growth (CPCG); Cell Culture Mod-
ule (CCM) A; Risk Mitigation Experiments

Extravehicular Activity (EVA) conducted by Scott
Parazynski and Vladimir Titov, 5 hours, 1 minute.
During this first U.S. spacewalk to include partici-
pation by a foreign astronaut, Parazynski and Titov
retrieved MEEP and tested hardware for future EVA
activities, including an evaluation of the Simplified
Aid for EVA Rescue (SAFER), a small jet-backpack
designed for use as a type of life jacket during
station assembly. They also retrieved a solar array
cap to be placed on the damaged Spektr module
to the exterior of the docking module.

STS-87 Mission Facts — Columbia — Nov. 19–Dec. 5, 1997

Commander: Kevin R. Kregel

Pilot: Steven W. Lindsey

Mission Specialist: Kalpana Chawla

Mission Specialist: Winston E. Scott

Mission Specialist: Takao Doi, National Space Develop-
ment Agency of Japan

Payload Specialist: Leonid Kadenyuk, National Space
Agency of Ukraine

Mission Duration: 360 hours (15 days), 16 hours,
35 minutes, 1 second

STS-87 Mission Facts (Cont)

Miles Traveled: Approximately 6.5 million statute miles

Inclination: 28.45 degrees

Orbits of Earth: 252

Orbital Altitude: 150 nautical miles (173 statute miles)

Liftoff Weight: Approximately 4,523,442 pounds

Orbiter Weight at Liftoff: Approximately 260,799 pounds

Payload Weight Up: Approximately 22,130 pounds

Payload Weight Down: Approximately 22,130 pounds

Orbiter Weight at Landing: Approximately
231,625 pounds

Landed: Concrete runway 33 at Kennedy Space Center,
Fla.

Payload: Shuttle Pointed Autonomous Research Tool
for Astronomy (SPARTAN) 201-04; United States
Microgravity Payload (SMP) 4; Extravehicular Activity
(EVA) Demonstration Flight Test (EDFT) 05; Shuttle
Ozone Limb Sounding Experiment (SOLSE); Loop
Heat Pipe (LHP); Sodium Sulfur Battery Experi-
ment (NaSBE); Turbulent Gas Jet Diffusion Flames
(TGDF); Getaway Special (GAS) 036; Shuttle
Ionospheric Modification With Pulsed Local Exhaust
(SIMPLEX); Collaborative Ukraine Experiment
(CUE); Autonomous EVA Robotic (AER) Camera/
Sprint; Midcourse Space Experiment (MSX)

Extravehicular Activity (EVA) conducted by Winston
Scott and Takao Doi during two spacewalks for
a total of 12 hours, 42 minutes. EVA 1, Scott and
Doi, 7 hours, 43 minutes; Scott and Doi manually
captured the SPARTAN satellite, whose attitude
control system had failed following its release from
Columbia's robot arm on Nov. 21. The two also
evaluated equipment and procedures that will be
used with future International Space Station opera-
tions. EVA 2, Scott and Doi, 4 hours, 59 minutes;
Scott and Doi completed tasks originally planned
for the mission's first spacewalk. They also used
the SPARTAN satellite as a laser target to prepare
for future automatic spacecraft dockings. In ad-
dition, they tested the AER Camera/Sprint, a free-
flying video camera designed to perform remote
inspections of the shuttle or station.

STS-89 Mission Facts — Endeavour — Jan. 22–31, 1998

Commander: Terrence W. Wilcutt

Pilot: Joe Frank Edwards Jr.

Mission Specialist: James F. Reilly II

Mission Specialist: Michael P. Anderson

Mission Specialist/Payload Commander: Bonnie J.
Dunbar

Mission Specialist: Salizhan Shakirovich Sharipov,
Russian Space Agency

STS-89 Mission Facts (Cont)

Mission Specialist: Andrew S.W. Thomas

Mission Specialist: David A. Wolf

Mission Duration: 192 hours (8 days), 19 hours, 48 minutes, 4 seconds

Miles Traveled: Approximately 3.6 million statute miles

Inclination: 51.6 degrees

Orbits of Earth: 139

Orbital Altitude: 213 nautical miles (245 statute miles)

Liftoff Weight: Approximately 4,512,608 pounds

Orbiter Weight at Liftoff: Approximately 251,692 pounds

Payload Weight Up: Approximately 21,940 pounds

Payload Weight Down: Approximately 19,529 pounds

Orbiter Weight at Landing: Approximately 216,241 pounds

Landed: Concrete runway 15 at Kennedy Space Center, Fla.

Payload: SPACEHAB 08 double module/Mir 08; transfer tunnel; transfer tunnel extension; orbiter docking system; Getaway Specials 093, 141, 145, and 432; Phase 1 requirements (Shuttle/Mir Mission 08 middeck science, mission support equipment and risk mitigation experiments); cosmic radiation effects and activation monitor (CREAM); Shuttle Ionospheric Modification With Pulsed Local Exhaust (SIMPLEX) payload of opportunity; EarthKAM (also known as KidSat); microgravity plant nutrient experiment (MPNE); human performance (HP) experiment; closed equilibrated biological aquatic system (CEBAS)

STS-90 Mission Facts — Columbia — April 17–May 3, 1998

Commander: Richard A. Searfoss

Pilot: Scott D. Altman

Mission Specialist: Kathryn “Kay” Hire

Mission Specialist: Richard M. Linnehan

Mission Specialist: Dafydd (Dave) Rhys Williams,
Canadian Space Agency

Payload Specialist: Dr. Jay C. Buckey

Payload Specialist: Dr. James A. Pawelczyk

Mission Duration: 360 hours (15 days), 21 hours, 50 minutes, 58 seconds

Miles Traveled: Approximately 6.375 million statute miles

Inclination: 39 degrees

Orbits of Earth: 256

Orbital Altitude: 150 nautical miles (173 statute miles)

Liftoff Weight: Approximately 4,523,770 pounds

Orbiter Weight at Liftoff: Approximately 262,357 pounds

Payload Weight Up: Approximately 26,150 pounds

STS-90 Mission Facts (Cont)

Payload Weight Down: Approximately 26,150 pounds

Orbiter Weight at Landing: Approximately 231,113 pounds

Landed: Concrete runway 33 at Kennedy Space Center, Fla.

Payload: Neurolab; Getaway Specials 197, 744 and 772; Shuttle Vibration Forces (SVFs); extended duration orbiter (EDO) cryogenic pallet; Bioreactor Demonstration System (BDS) 04

STS-91 Mission Facts — Discovery— June 2–12, 1998

Commander: Charles J. Precourt

Pilot: Dominic L. Gorie

Mission Specialist: Franklin Chang-Diaz

Mission Specialist: Wendy Lawrence

Mission Specialist: Janet Kavandi

Mission Specialist: Valeriy Ryumin, Russian Space Agency

Mission Specialist: Andrew S.W. Thomas—down only

Mission Duration: 216 hours (9 days), 19 hours, 55 minutes, 1 second

Miles Traveled: Approximately 3.8 million statute miles

Inclination: 51.6 degrees

Orbits of Earth: 155

Orbital Altitude: 213 nautical miles (245 statute miles)

Liftoff Weight: Approximately 4,514,510 pounds

Orbiter Weight at Liftoff: Approximately 259,834 pounds

Payload Weight Up: Approximately 25,922 pounds

Payload Weight Down: Approximately 26,109 pounds

Orbiter Weight at Landing: Approximately 225,276 pounds

Landed: Concrete runway 15 at Kennedy Space Center, Fla.

Payload: SPACEHAB 09 single module/Mir 09; orbiter docking system; getaway specials (8): G-090, G-743, G-765, G-648, two Space Experiment Modules (SEMs) (SEM 03 and SEM 05), two Phase 1 Program Support Packages (PH1 PSP1 and PH1 PSP2); Alpha Magnetic Spectrometer (AMS); Phase 1 requirements (Shuttle/Mir Mission 09 middeck science, mission support equipment and risk mitigation experiments); Commercial Protein Crystal Growth (CPCG); Solid Surface Combustion Experiment (SSCE); Shuttle Ionospheric Modification with Pulsed Local Exhaust (SIMPLEX, payload of opportunity)

**STS-95 Mission Facts — Discovery—
Oct. 29–Nov. 7, 1998**

Commander: Curtis L. Brown Jr.

Pilot: Steven W. Lindsey

Mission Specialist: Scott E. Parazynski

Mission Specialist: Stephen K. Robinson

Mission Specialist: Pedro Duque, European Space Agency

Payload Specialist: Chiaki Mukai, National Space Development Agency of Japan

Payload Specialist: Senator John Glenn

Mission Duration: 192 hours (8 days), 21 hours, 44 minutes, 56 seconds

Miles Traveled: Approximately 3.6 million statute miles

Inclination: 28.45 degrees

Orbits of Earth: 135

Orbital Altitude: 300 nautical miles (345 statute miles)

Liftoff Weight: Approximately 4,521,918 pounds

Orbiter Weight at Liftoff: Approximately 227,207 pounds

Payload Weight Up: Approximately 28,520 pounds

Payload Weight Down: Approximately 28,367 pounds

Orbiter Weight at Landing: Approximately 227,783 pounds

Landed: Kennedy Space Center, Fla.

Payload: SPACEHAB; SPARTAN 201-5; Hubble Space Telescope Orbital Systems Test Platform (HOST); International Extreme Ultraviolet Hitchhiker (IEH)-3; Cryogenic Thermal Storage Unit (CRYOTSU); Space Experiment Module (SEM)-4; Getaway Special (GAS) program; Biological Research in Canisters (BRIC); Electronic Nose (E-NOSE)

**STS-88 Mission Facts — Endeavour—
Dec. 4–15, 1998**

Commander: Robert D. Cabana

Pilot: Frederick W. "Rick" Sturckow

Mission Specialist: Nancy J. Currie

Mission Specialist: Jerry L. Ross

Mission Specialist: James H. Newman

Mission Specialist: Sergei Konstantinovich Krikalev, Russian Space Agency

Mission Duration: 264 hours (11 days), 19 hours, 18 minutes, 47 seconds

Miles Traveled: Approximately 4.6 million statute miles

Inclination: 51.6 degrees

Orbits of Earth: 186

Orbital Altitude: 173 nautical miles (199 statute miles)

Liftoff Weight: Approximately 4,518,390 pounds

Orbiter Weight at Liftoff: Approximately 263,927 pounds

Payload Weight Up: Approximately 30,986 pounds

STS-88 Mission Facts (Cont)

Payload Weight Down: Approximately 4,500 pounds

Orbiter Weight at Landing: Approximately 200,296 pounds

Landed: Concrete runway 15 at Kennedy Space Center, Fla.

Payload: ISS Unity connecting module; IMAX cargo bay camera (ICBC); Satellite de Aplicaciones/Científico A (SAC-A); MightySat 1; Space Experiment Module (SEM) 07; Getaway Special G-093

Extravehicular Activity (EVA) conducted by Jerry Ross and James Newman during three spacewalks for a total of 21 hours, 22 minutes. EVA 1, Ross and Newman, 7 hours, 21 minutes; Ross and Newman made all umbilical connections necessary to activate Node 1. Upon completion, the ground sent commands to the node to confirm power and activation. EVA 2, Ross and Newman, 7 hours, 2 minutes; Ross and Newman installed EVA translation aids and tools and early communications system antennas and routed the communication cable from the FGB to the starboard antenna. EVA 3, Ross and Newman, 6 hours, 59 minutes; EVA 3 was performed to support objectives of downstream assembly missions. Tasks included installation of a large tool bag for storing EVA tools outside the station and repositioning foot restraints. Additionally, Ross and Newman disconnected the umbilical on PMA-2 so that PMA-2 can be relocated in the future.

STS-96 Mission Facts — Discovery — May 27–June 6, 1999

Commander: Kent V. Rominger

Pilot: Rick D. Husband

Mission Specialist: Ellen Ochoa

Mission Specialist: Tamara E. Jernigan

Mission Specialist: Daniel T. Barry

Mission Specialist: Julie Payette, Canadian Space Agency

Mission Specialist: Valery Ivanovich Tokarev, Russian Space Agency

Mission Duration: 216 hours (9 days), 19 hours, 13 minutes, 57 seconds

Miles Traveled: Approximately 4,051,000 statute miles

Inclination: 51.6 degrees

Orbits of Earth: 154

Orbital Altitude: 173 nautical miles (199 statute miles)

Liftoff Weight: Approximately 4,514,231 pounds

Orbiter Weight at Liftoff: Approximately 227,974 pounds

Payload Weight Up: Approximately 22,707 pounds

Payload Weight Down: Approximately 19,390 pounds

STS-96 Mission Facts (Cont)

Orbiter Weight at Landing: Approximately 221,664 pounds

Landed: Concrete runway 15 at Kennedy Space Center, Fla.

Payload: International Space Station (A.1); SPACEHAB double module; Integrated Vehicle Health Monitoring HEDS Technology Demonstration 2; Student-Tracked Atmospheric Research Satellite for Heuristic International Networking Equipment (STARSHINE); Shuttle Vibration Forces Experiment; MIRTS change-out; cargo transfer

Extravehicular Activity (EVA) conducted by Tamara Jernigan and Daniel Barry, 7 hours, 55 minutes. During the EVA, Jernigan and Barry transferred and installed two cranes from the shuttle's payload bay to locations on the outside of the station. They also installed two new portable foot restraints that will fit both American and Russian space boots and attached three bags filled with tools and handrails that will be used during future assembly operations. Once those primary tasks were accomplished, Jernigan and Barry installed an insulating cover on a trunnion pin on the Unity module, documented painted surfaces on both the Unity and Zarya modules, and inspected one of two early communications system antennas on the Unity. Other tasks completed during the spacewalk included moving foot restraints into PMA-1 (pressurized mating adapter) and installing three bags containing tools for use during later flights. Throughout the spacewalk, Jernigan and Barry were assisted by their crew mates as Mission Specialist Ellen Ochoa operated the shuttle's robot arm to maneuver Jernigan around Discovery's cargo bay, and Canadian Space Agency astronaut Julie Payette acted as "choreographer" of the spacewalk from Discovery's flight deck.

STS-93 Mission Facts — Columbia — July 23–27, 1999

Commander: Eileen M. Collins

Pilot: Jeffrey S. Ashby

Mission Specialist: Steven A. Hawley

Mission Specialist: Catherine G. Coleman

Mission Specialist: Michael Tognini, Centre National d'Etudes Spatiales (CNES)

Mission Duration: 96 hours (4 days), 22 hours, 50 minutes, 22 seconds

Miles Traveled: Approximately 1.8 million statute miles

Inclination: 28.45 degrees

Orbits of Earth: 80

STS-93 Mission Facts (Cont)

Orbital Altitude: 153 nautical miles (176 statute miles)

Liftoff Weight: Approximately 4,524,972 pounds

Orbiter Weight at Liftoff: Approximately 270,387 pounds

Payload Weight Up: Approximately 49,789 pounds

Payload Weight Down: Approximately 6,709 pounds

Orbiter Weight at Landing: Approximately 202,338 pounds

Landed: Concrete runway 33 at Kennedy Space Center, Fla.

Payload: Chandra X-Ray Observatory (CXO); Plant Growth Investigations in Microgravity 1; Southwest Ultraviolet Imaging System; Gelation of Sols: Applied Microgravity Research; Space Tissue Loss; Lightweight Flexible Solar Array Hinge; Cell Culture Module, Configuration C; Shuttle Amateur Radio Experiment II; Commercial Generic Bioprocessing Apparatus; Micro-Electro-Mechanical Systems; Biological Research in Canisters (BRIC)

STS-103 Mission Facts — Discovery — Dec. 19–27, 1999

Commander: Curtis L. Brown

Pilot: Scott J. Kelly

Mission Specialist: Jean-Francois Clervoy, European Space Agency

Mission Specialist: Steven L. Smith

Mission Specialist: C. Michael Foale

Mission Specialist: John M. Grunsfeld

Mission Specialist: Claude Nicollier, European Space Agency

Mission Duration: 168 hours (7 days), 23 hours, 10 minutes, 47 seconds

Miles Traveled: Approximately 3,267,000 statute miles

Inclination: 28.45 degrees

Orbits of Earth: 120

Orbital Altitude: 317 nautical miles (365 statute miles)

Liftoff Weight: Approximately 4,506,419 pounds

Orbiter Weight at Liftoff: Approximately 248,159 pounds

Payload Weight Up: Approximately 13,208 pounds

Payload Weight Down: Approximately 13,136 pounds

Orbiter Weight at Landing: Approximately 210,977 pounds

Landed: Concrete runway 33 at Kennedy Space Center, Fla.

Payload: Hubble Space Telescope servicing mission 03-A (fine guidance sensor; gyroscopes; new advanced computer; new thermal blanket layers; S-band single-access transmitter; solid-state recorder; and voltage/temperature improvement kits)

STS-103 Mission Facts (Cont)

Extravehicular Activity (EVA) conducted by Steven Smith, John Grunsfeld, Michael Foale, and Claude Nicollier during three spacewalks for a total of 24 hours, 33 minutes. EVA 1, Smith and Grunsfeld, 8 hours, 15 minutes; Smith and Grunsfeld installed six new gyroscopes and six voltage/temperature improvement kits in the telescope. EVA 2, Foale and Nicollier, 8 hours, 10 minutes; Foale and Nicollier installed a new advanced computer, 20 times faster and with six times the memory of the previous machine, and replaced a 550-pound fine guidance sensor, one of three on the telescope. EVA 3, Smith and Grunsfeld, 8 hours, 8 minutes; Smith and Grunsfeld replaced a failed radio transmitter and installed a new digital solid-state recorder that will provide more than 10 times the storage capacity of the old unit. They also applied new insulation on two equipment bay doors. Both the transmitter and the recorder checked out normally on early tests by telescope controllers.

STS-99 Mission Facts — Endeavour — Feb. 11–22, 2000

Commander: Kevin R. Kregel

Pilot: Dominic L. Gorie

Mission Specialist: Gerhard P.J. Thiele

Mission Specialist: Janet L. Kavandi

Mission Specialist: Janice Voss

Mission Specialist: Mamoru Mohri

Mission Duration: 264 hours (11 days), 5 hours,
38 minutes

Miles Traveled: Approximately 4 million statute miles

Inclination: 57 degrees

Orbits of Earth: 182

Orbital Altitude: 126 nautical miles (145 statute miles)

Liftoff Weight: Approximately 4,520,415 pounds

Orbiter Weight at Liftoff: Approximately 256,560 pounds

Payload Weight Up: Approximately 29,000 pounds

Payload Weight Down: Approximately 28,740 pounds

Orbiter Weight at Landing: 225,669 pounds

Landed: Concrete runway 33 at Kennedy Space Center,
Fla.

Payload: Shuttle Radar Topography Mission hardware
(mast, antenna, and data recording, processing
products)

STS-101/2A.2a Mission Facts — Atlantis — May 19–29, 2000

Commander: James D. Halsell

Pilot: Scott J. Horowitz

Mission Specialist: Mary Ellen Weber

Mission Specialist: Jeffrey N. Williams

STS-101/2A.2a Mission Facts (Cont)

Mission Specialist: James S. Voss

Mission Specialist: Susan J. Helms

Mission Specialist: Yuri V. Usachev

Mission Duration: 216 hours (9 days), 20 hours,
10 minutes

Miles Traveled: 4,076,241 statute miles

Inclination: 51.6 degrees

Orbits of Earth: 156

Orbital Altitude: 173 nautical miles (259 statute miles)

Liftoff Weight: 4,519,645 pounds

Orbiter Weight at Liftoff: 262,528 pounds

Payload Weight Up: 24,733 pounds

Payload Weight Down: 23,074 pounds

Orbiter Weight at Landing: 221,271 pounds

Landed: Concrete runway 15 at Kennedy Space Center,
Fla.

Payload: BioTube precursor experiment; SPACEHAB;
integrated cargo carrier; mission to America's
remarkable schools; space experiment module 6;
HTD 1403 micro wireless instrumentation system
HEDS technology demonstration

Extravehicular Activity (EVA) conducted by James Voss
and Jeffrey Williams, 6 hours, 44 minutes. During
the EVA, Voss and Williams made the last planned
equipment changes prior to the arrival of the ISS's
third element, Russia's service module Zvezda.
They completed assembly of a Russian crane,
tested the integrity of a U.S. crane, replaced a faulty
communications antenna, installed handrails, and
set up a camera cable.

STS-106/2A.2b Mission Facts — Atlantis — Sept. 8–20, 2000

Commander: Terrence Wilcutt

Pilot: Scott D. Altman

Mission Specialist: Edward T. Lu

Mission Specialist: Richard A. Mastracchio

Mission Specialist: Daniel C. Burbank

Mission Specialist: Yuri I. Malenchenko

Mission Specialist: Boris V. Morukov

Mission Duration: 283 hours (11 days), 19 hours,
11 minutes

Miles Traveled: 4.9 million

Inclination: 51.6 degrees

Orbits of Earth: 185

Orbital Altitude: 177 nautical miles (203 statute miles)

Liftoff Weight: 4,519,178 pounds

Orbiter Weight at Liftoff: 262,053 pounds

Payload Weight Up: 23,967 pounds

STS-106/2A.2b Mission Facts (Cont)

Payload Weight Down: 20,173 pounds

Orbiter Weight at Landing: 221,803 pounds

Landed: Concrete runway 15 at Kennedy Space Center, Fla.

Payload: Space Experiment Module 8; Getaway Special G-782; SPACEHAB Logistics Double Module (in cargo bay); Commercial Generic Bioprocessing Apparatus (in-cabin)

Extravehicular Activity (EVA) conducted by Edward Lu and Yuri Malenchenko, 6 hours, 14 minutes. This was the sixth spacewalk in support of the assembly of the ISS and the 50th in shuttle history. During the EVA, the two made the grueling ascent to lay cable and install a boom for a navigation unit on the exterior of the ISS. They ventured 110 feet from the shuttle cargo bay, the farthest distance any NASA spacewalker has ever ventured while tethered. They had to scale the Russian service module Zvezda to erect the boom for a compass and to install the cables between Zvezda and the other Russian module, Zarya.

STS-92 Mission Facts — Discovery — Oct. 11–24, 2000

Commander: Brian Duffy

Pilot: Pamela Ann Melroy

Mission Specialist: Koichi Wakata, National Space Development Agency of Japan

Mission Specialist: Peter J.K. (Jeff) Wisoff

Mission Specialist: Leroy Chiao

Mission Specialist: William S. McArthur Jr.

Mission Specialist: Michael E. Lopez-Alegria

Mission Duration: 288 hours (12 days), 21 hours, 43 minutes, 47 seconds

Miles Traveled: Approximately 5.3 million statute miles

Inclination: 51.6 degrees

Orbits of Earth: 203

Orbital Altitude: 173 nautical miles (259 statute miles)

Liftoff Weight: Approximately 4,520,596 pounds

Orbiter Weight at Liftoff: 253,807 pounds

Payload Weight Up: 28,009 pounds

Payload Weight Down: 6,304 pounds

Orbiter Weight at Landing: 204,455 pounds

Landed: Concrete runway 22 at Edwards Air Force Base, Calif.

Payload: International Space Station (3A); Z1 truss; pressurized mating adapter 3 (PMA-3); cargo transfer

STS-92 Mission Facts (Cont)

Extravehicular Activity (EVA) conducted by Leroy Chiao, William McArthur, Jeff Wisoff, and Michael Lopez-Alegria during four spacewalks for a total of 27 hours, 19 minutes. EVA 1, Chiao and McArthur, 6 hours, 28 minutes. Chiao and McArthur relocated the S-band antenna support assembly on the Z1 truss and connected Z1-to-Unity umbilicals. EVA 2, Wisoff and Lopez-Alegria, 7 hours, 7 minutes. During EVA 2, Koichi Wakata used the shuttle's robotic arm to grapple and install PMA-3 on Unity's nadir port. Wisoff and Lopez-Alegria connected cables between PMA-3 and Unity. EVA 3, Chiao and McArthur, 6 hours, 48 minutes. Chiao and McArthur installed two DC-to-DC converter unit heat pipes on the Z1 truss and relocated the Z1 keel pin assembly. EVA 4, Wisoff and Lopez-Alegria, 6 hours, 56 minutes. Wisoff and Lopez-Alegria removed a grapple fixture on the Z1 truss. Wisoff and Lopez-Alegria also performed a safety protocol test, a flight evaluation of simplified aid for EVA rescue (SAFER).

Of Note: 100th space shuttle mission

STS-97 Mission Facts — Endeavour — Nov. 30–Dec. 11, 2000

Commander: Brent W. Jett Jr.

Pilot: Michael J. Bloomfield

Mission Specialist: Marc Garneau, Canadian Space Agency

Mission Specialist: Joseph R. Tanner

Mission Specialist: Carlos I. Noriega

Mission Duration: 240 hours (10 days), 19 hours, 58 minutes

Miles Traveled: Approximately 4.47 million statute miles

Inclination: 51.6 degrees

Orbits of Earth: 170

Orbital Altitude: 205 nautical miles

Liftoff Weight: 4,524,795 pounds

Orbiter Weight at Liftoff: 266,570 pounds

Payload Weight Up: 37,496 pounds

Payload Weight Down: 1,920 pounds

Orbiter Weight at Landing: 197,377 pounds

Landed: Concrete runway 15 at Kennedy Space Center, Fla.

Payload: International Space Station (4A); P6 photovoltaic array assembly; integrated equipment assembly

Extravehicular Activity (EVA) conducted by Joseph Tanner and Carlos Noriega during three spacewalks for a total of 19 hours, 20 minutes. EVA 1, Tanner and Noriega, 7 hours, 33 minutes; Tanner and

STS-97 Mission Facts (Cont)

Noriega attached the P6 integrated truss structure to the Z1 truss, prepared the solar arrays for deployment, and prepared the radiator for power system deployment. EVA 2, Tanner and Noriega, 6 hours, 37 minutes; Tanner and Noriega configured the ISS for use of the power from the P6, positioned the S-band for use by the space station, and prepared the ISS for the arrival of the U.S. Laboratory on mission ISS-5A. EVA 3, Tanner and Noriega, 5 hours, 10 minutes; Tanner and Noriega performed repair work to increase tension in the starboard solar array blankets and performed get-ahead tasks that were planned for future space station assembly missions.

STS-98 Mission Facts — Atlantis — Feb. 7–20, 2001

Commander: Kenneth D. Cockrell

Pilot: Mark L. Polansky

Mission Specialist: Marsha Ivins

Mission Specialist: Thomas D. Jones

Mission Specialist: Robert L. Curbeam Jr.

Mission Duration: 288 hours (12 days), 21 hours, 20 minutes

Miles Traveled: Approximately 5.3 million statute miles

Inclination: 51.6 degrees

Orbits of Earth: 203

Orbital Altitude: Approximately 200 nautical miles

Liftoff Weight: Approximately 4.5 million pounds

Orbiter Weight at Liftoff: 264,127 pounds

Payload Weight Up: 33,286 pounds

Payload Weight Down: 2,673 pounds

Orbiter Weight at Landing: 198,849 pounds

Landed: Concrete runway 22 at Edwards Air Force Base, Calif.

Payload: ISS Assembly Flight 5A; U.S. Laboratory Module "Destiny"

Extravehicular Activity (EVA) conducted by Robert Curbeam and Thomas Jones during three spacewalks for a total of 19 hours, 48 minutes. EVA 1, Curbeam and Jones, 7 hours, 34 minutes; Curbeam and Jones installed and hooked up Destiny to ISS's Unity module. EVA 2, Curbeam and Jones, 6 hours, 50 minutes; Curbeam and Jones attached a station docking adapter to the forward end of Destiny to establish a new docking port for future shuttle assembly flights. EVA 3, Curbeam and Jones, 5 hours, 25 minutes, the 100th spacewalk in U.S. space program history; Curbeam and Jones attached a spare communications antenna on the exterior of the ISS and inspected the exterior of the ISS and the U.S. solar arrays.

**STS-102 Mission Facts — Discovery —
March 8–21, 2001**

Commander: James D. Weatherbee

Pilot: James M. Kelly

Mission Specialist: Andrew S.W. Thomas

Mission Specialist: Paul W. Richards

ISS Crew Member: Yury V. Usachev—up only

ISS Crew Member: Susan J. Helms—up only

ISS Crew Member: James S. Voss—up only

ISS Crew Member: William M. Shepherd—down only

ISS Crew Member: Sergei K. Krikalev—down only

ISS Crew Member: Yuri P. Gidzenko—down only

Mission Duration: 288 hours (12 days), 19 hours,
49 minutes

Miles Traveled: Approximately 5.4 million statute miles

Inclination: 51.6 degrees

Orbits of Earth: 202

Orbital Altitude: 205 nautical miles

Liftoff Weight: Approximately 4.5 million pounds

Orbiter Weight at Liftoff: 264,797 pounds

Payload Weight Up: 28,739 pounds

Payload Weight Down: 20,389 pounds

Orbiter Weight at Landing: 217,771 pounds

Landed: Concrete runway 15 at Kennedy Space Center,
Fla.

Payload: ISS Assembly Flight 5A.1; Leonardo Multi-Purpose Logistics Module; External Stowage Platform 1

Extravehicular Activity (EVA) conducted by Susan Helms, James Voss, Paul Richards, and Andy Thomas during two spacewalks for a total of 15 hours, 16 minutes. EVA 1, Helms and Voss, 8 hours, 56 minutes; Helms and Voss prepared one of ISS's berthing ports for the Leonardo transfer module. EVA 2, Richards and Thomas, 6 hours, 30 minutes; Richards and Thomas continued work to outfit the station and prepare for delivery of its own robotic arm on the next mission.

**STS-100 Mission Facts — Endeavour —
April 19–May 1, 2001**

Commander: Kent V. Rominger

Pilot: Jeffrey S. Ashby

Mission Specialist: Chris A. Hadfield, Canadian Space Agency

Mission Specialist: John L. Phillips

Mission Specialist: Scott E. Parazynski

Mission Specialist: Umberto Guidoni, European Space Agency

Mission Specialist: Yuri Valentinovich Lonchakov, Russian Air Force

Mission Duration: 264 hours (11 days), 21 hours,
30 minutes

STS-100 Mission Facts (Cont)

Miles Traveled: Approximately 4.9 million statute miles

Inclination: 51.6 degrees

Orbits of Earth: 186

Orbital Altitude: 240 nautical miles

Liftoff Weight: 4,522,246 pounds

Orbiter Weight at Liftoff: 265,268 pounds

Payload Weight Up: 29,472 pounds

Payload Weight Down: 20,346 pounds

Orbiter Weight at Landing: 220,125 pounds

Landed: Concrete runway 22 at Edwards Air Force Base, Calif.

Payload: ISS Assembly Flight 6A; Raffaello Multi-Purpose Logistics Module; Space Station Remote Manipulator System (SSRMS), also known as Canadarm2; UHF antenna

Extravehicular Activity (EVA) conducted by Scott Parazynski and Chris Hadfield during two spacewalks for a total of 14 hours, 50 minutes. EVA 1, 7 hours, 10 minutes; Parazynski and Hadfield installed and deployed the UHF antenna on Destiny and began installation of Canadarm2. EVA 2, 7 hours, 40 minutes; Parazynski and Hadfield completed power and data connections on Canadarm2.

STS-104 Mission Facts — Atlantis — July 12–24, 2001

Commander: Steven W. Lindsey

Pilot: Charles O. Hobaugh

Mission Specialist: Michael L. Gernhardt

Mission Specialist: James F. Reilly

Mission Specialist: Janet L. Kavandi

Mission Duration: 288 hours (12 days), 18 hours, 35 minutes

Miles Traveled: Approximately 5.3 million statute miles

Inclination: 51.6 degrees

Orbits of Earth: 200

Orbital Altitude: 240 nautical miles

Liftoff Weight: 4,520,159 pounds

Orbiter Weight at Liftoff: 262,952 pounds

Payload Weight Up: 26,424 pounds

Payload Weight Down: 7,268 pounds

Orbiter Weight at Landing: 206,902 pounds

Landed: Concrete runway 15 at Kennedy Space Center, Fla.

Payload: ISS Assembly Flight 7A; Joint Airlock and High-Pressure Gas Tanks; first flight of Block II main engine high-pressure fuel turbopump

STS-104 Mission Facts (Cont)

Extravehicular Activity (EVA) conducted by Michael Gernhardt and James Reilly during two spacewalks for a total of 12 hours, 25 minutes. EVA 1, 5 hours, 59 minutes; Gernhardt and Reilly assisted space station robot arm operator Susan Helms with installation of the joint airlock onto the station. EVA 2, 6 hours, 29 minutes; Gernhardt and Reilly installed three high-pressure gas tanks (two oxygen and one nitrogen) onto the joint airlock. EVA 3, 4 hours, 2 minutes; Gernhardt and Reilly, conducting first spacewalk from new joint airlock, installed fourth high-pressure gas tank (nitrogen) onto the joint airlock, plus handholds and communications cables.

STS-105 Mission Facts — Discovery — Aug. 10–22, 2001

Commander: Scott J. Horowitz

Pilot: Rick Sturckow

Mission Specialist: Daniel T. Barry

Mission Specialist: Patrick G. Forrester

ISS Crew Member: Frank L. Culbertson Jr.—up only

ISS Crew Member: Vladimir N. Dezhurov, Russian Space Agency—up only

ISS Crew Member: Mikhail Turin, Russian Space Agency—up only

ISS Crew Member: Yury V. Usachev, Russian Space Agency—down only

ISS Crew Member: James S. Voss—down only

ISS Crew Member: Susan J. Helms—down only

Mission Duration: 264 hours (11 days), 21 hours, 13 minutes

Miles Traveled: Approximately 4.3 million statute miles

Inclination: 51.6 degrees

Orbits of Earth: 186

Orbital Altitude: 240 nautical miles

Liftoff Weight: 4,518,170 pounds

Orbiter Weight at Liftoff: 262,477 pounds

Payload Weight Up: 29,305 pounds

Payload Weight Down: 23,456 pounds

Orbiter Weight at Landing: 222,250 pounds

Landed: Concrete runway 15 at Kennedy Space Center, Fla.

Payload: ISS Assembly Flight 7A.1; Leonardo Multi-Purpose Logistics Module (MPLM); second ISS crew exchange

STS-105 Mission Facts (Cont)

Extravehicular Activity (EVA) conducted by Daniel Barry and Patrick Forrester during two spacewalks for a total of 11 hours, 45 minutes. EVA 1, 6 hours, 16 minutes; Barry and Forrester installed an early ammonia servicer onto the P6 truss and installed the Materials International Space Station Experiment onto the joint airlock. EVA 2, 5 hours, 29 minutes; Barry and Forrester installed handrails and heater cables onto the U.S. Laboratory.

STS-108 Mission Facts — Endeavour — Dec. 5–17, 2001

Commander: Dominic L. Gorie

Pilot: Mark E. Kelly

Mission Specialist: Linda M. Godwin

Mission Specialist: Daniel M. Tani

ISS Crew Member: Yuri I. Onufrienko, Russian Space Agency—up only

ISS Crew Member: Daniel W. Bursch—up only

ISS Crew Member: Carl E. Walz—up only

ISS Crew Member: Frank L. Culbertson—down only

ISS Crew Member: Vladimir N. Dezhurov, Russian Space Agency—down only

ISS Crew Member: Mikhail Turin, Russian Space Agency—down only

Mission Duration: 264 hours (11 days), 19 hours, 37 minutes

Miles Traveled: Approximately 4.8 million statute miles

Orbits of Earth: 185

Inclination: 51.6 degrees

Orbital Altitude: 205 nautical miles

Liftoff Weight: 4,519,872 pounds

Payload Weight Up: 31,393 pounds

Payload Weight Down: 28,826 pounds

Orbiter Weight at Landing: 225,169 pounds

Landed: Concrete runway 15 at Kennedy Space Center, Fla.

Payload: ISS Assembly Flight UF-1; Raffaello Multi-Purpose Logistics Module; Multiple Application Customized Hitchhiker-1; STARSHINE 2; "Flags for Heroes and Families" in honor of the victims of 9-11-01; third ISS crew exchange

Extravehicular Activity (EVA) conducted by Linda Godwin and Daniel Tani; 4 hours, 12 minutes. Godwin and Tani installed insulation on mechanisms that rotate the International Space Station's main solar arrays. This completed a record year for spacewalks, with 12 spacewalks originating from the space shuttle and six from the space station.

**STS-109 Mission Facts — Columbia —
March 1–12, 2002**

Commander: Scott D. Altman

Pilot: Duane G. Carey

Payload Commander: John M. Grunsfeld

Mission Specialist: Nancy J. Currie

Mission Specialist: James H. Newman

Mission Specialist: Richard M. Linnehan

Mission Specialist: Michael J. Massimino

Mission Duration: 240 hours (10 days), 22 hours,
11 minutes

Miles Traveled: Approximately 3.9 million statute miles

Orbits of Earth: 165

Inclination: 28.5 degrees

Orbital Altitude: 308 nautical miles

Liftoff Weight: 4,515,646 pounds

Orbiter Weight at Liftoff: 260,665 pounds

Payload Weight Up: 27,594 pounds

Payload Weight Down: 25,717 pounds

Orbiter Weight at Landing: 258,788 pounds

Landed: Concrete runway 33 at Kennedy Space Center,
Fla.

Payload: Hubble Space Telescope Servicing Mission 3B; Advanced Camera for Surveys; new rigid solar arrays (SA3); new power control unit (PCU); new cryocooler for Near-Infrared Camera and Multi-Object Spectrometer (NICMOS); reaction wheel assembly (RWA1)

Extravehicular Activity (EVA) conducted by John Grunsfeld, Richard Linnehan, James Newman, and Michael Massimino during five spacewalks for a total of 35 hours, 55 minutes. EVA 1, 7 hours, 1 minute; Grunsfeld and Linnehan replaced the starboard solar array. EVA 2, 7 hours, 16 minutes; Newman and Massimino replaced the port solar array and reaction wheel assembly. EVA 3, 6 hours, 48 minutes; Grunsfeld and Linnehan replaced the power control unit. EVA 4, 7 hours, 30 minutes; Newman and Massimino replaced the Faint Object Camera with the Advanced Camera for Surveys. EVA 5, 7 hours, 20 minutes; Grunsfeld and Linnehan installed a new cooling system for the Near-Infrared Camera and Multi-Object Spectrometer.

**STS-110 Mission Facts — Atlantis —
April 8–19, 2002**

Commander: Michael J. Bloomfield

Pilot: Stephen N. Frick

Mission Specialist: Jerry L. Ross

Mission Specialist: Steven L. Smith

Mission Specialist: Ellen Ochoa

Mission Specialist: Lee M.E. Morin

STS-110 Mission Facts (Cont)

Mission Specialist: Rex J. Walheim

Mission Duration: 240 hours (10 days), 19 hours, 42 minutes

Miles Traveled: Approximately 4.5 million statute miles

Orbits of Earth: 171

Inclination: 51.6 degrees

Orbital Altitude: 247 nautical miles

Liftoff Weight: 4,520,940 pounds

Orbiter Weight at Liftoff: 257,079 pounds

Payload Weight Up: 28,379 pounds

Payload Weight Down: 1,493 pounds

Orbiter Weight at Landing: 200,657 pounds

Landed: Concrete runway 33 at Kennedy Space Center, Fla.

Payload: ISS Assembly Flight 8A; Starboard-zero (S0) Central Integrated Truss Structure; Mobile Transporter, which will be attached to the Mobile Base System during STS-111 to create the first “railroad in space”; first flight of three Block II main engines

Extravehicular Activity (EVA) conducted by Steven Smith, Rex Walheim, Jerry Ross, and Lee Morin during four spacewalks for a total of 28 hours, 10 minutes. EVA 1, 7 hours, 48 minutes; after the S0 truss was lifted by the Canadarm2 from Atlantis’s cargo bay and installed on the U.S. Laboratory, Smith and Walheim made power and data connections and bolted two forward struts. EVA 2, 7 hours, 30 minutes; Ross and Morin continued power and data connections between the S0 and ISS and bolted two aft struts. EVA 3, 6 hours, 27 minutes; Smith and Walheim installed power connections for Canadarm2 to use when on the truss. EVA 4, 6 hours, 25 minutes; Ross and Morin installed a beam called the Airlock Spur between the Quest airlock and the S0 and installed handrails on the S0. Ross set new record for most spacewalks (nine), as well as a new record for most space shuttle missions (seven).

STS-111 Mission Facts — Endeavour — June 5–19, 2002

Commander: Kenneth D. Cockrell

Pilot: Paul S. Lockhart

Mission Specialist: Franklin R. Chang-Diaz

Mission Specialist: Philippe Perrin, Centre National D’Etudes Spatiales (CNES, French Space Agency)

ISS Crew Member: Valery G. Korzun, Russian Space Agency—up only

ISS Crew Member: Peggy A. Whitson—up only

ISS Crew Member: Sergei Y. Treschev, Russian Space Agency—up only

STS-111 Mission Facts (Cont)

ISS Crew Member: Yuri I. Onufrienko, Russian Space Agency—down only

ISS Crew Member: Carl E. Walz—down only

ISS Crew Member: Daniel W. Bursch—down only

Mission Duration: 312 hours (13 days), 20 hours, 35 minutes

Miles Traveled: Approximately 5.78 million statute miles

Orbits of Earth: 217

Inclination: 51.6 degrees

Orbital Altitude: Approximately 240 nautical miles

Liftoff Weight: 4,518,239 pounds

Orbiter Weight at Liftoff: 256,884 pounds

Payload Weight Up: 29,810 pounds

Payload Weight Down: 22,099 pounds

Orbiter Weight at Landing: 219,103 pounds

Landed: Concrete runway 22 at Edwards Air Force Base, Calif.

Payload: ISS Utilization Flight UF-2; Leonardo Multi-Purpose Logistics Module carrying experiment racks, equipment, and supplies; Mobile Base System (MBS) installed on Mobile Transporter (MT) to complete Mobile Servicing System; replacement of Canadarm2 wrist roll joint; and fourth ISS crew exchange. ISS crew members Walz and Bursch set new record for longest U.S. space flight (196 days), breaking the previous record of 188 days in space held by Shannon Lucid aboard the Russian space station Mir.

Extravehicular Activity (EVA) conducted by Franklin Chang-Diaz and Philippe Perrin during three spacewalks for a total of 19 hours, 31 minutes. EVA 1, 7 hours, 14 minutes; Chang-Diaz and Perrin attached a power and data grapple fixture onto the P6 truss, setting the stage for the future relocation of the P6, and removed thermal blankets to prepare MBS for installation. Whitson and Walz used Canadarm2 to lift the MBS out of the payload bay. EVA 2, 5 hours, 0 minute; the focus was on outfitting and permanently attaching the MBS to the MT. Chang-Diaz and Perrin attached power, data, and video cables from the station to the MBS. EVA 3, 7 hours, 17 minutes; Chang-Diaz and Perrin replaced Canadarm2's wrist roll joint.

STS-112 Mission Facts — Atlantis — Oct. 7–18, 2002

Commander: Jeffrey S. Ashby

Pilot: Pamela A. Melroy

Mission Specialist: David A. Wolf

Mission Specialist: Piers J. Sellers

Mission Specialist: Sandra H. Magnus

STS-112 Mission Facts (Cont)

Mission Specialist: Fyodor N. Yurchikhin, Russian Space Agency

Launched: 3:45:51 p.m. EDT, launch pad 39B, Kennedy Space Center, Fla.

Mission Duration: 240 hours (10 days), 19 hours, 58 minutes

Miles Traveled: Approximately 4.5 million statute miles

Orbits of Earth: 170

Inclination: 51.6 degrees

Orbital Altitude: 210 nautical miles

Liftoff Weight: 4,521,314 pounds

Orbiter Weight at Liftoff: 265,812 pounds

Payload Weight Up: 29,502 pounds

Payload Weight Down: 1,733 pounds

Orbiter Weight at Landing: 201,299 pounds

Landed: 11:44:35 a.m. EDT, concrete runway 33, Kennedy Space Center, Fla.

Payload: ISS Assembly Flight 9A; 14-ton Starboard-One (S1) truss structure preintegrated with a standard Tracking and Data Relay Satellite System (TDRSS) transponder, Audio Communication System (ACS) baseband signal processor, S-band communication equipment, Thermal Radiator Rotary Joint (TRRJ), three External Active Thermal Control System (EATCS) radiators, Direct Current (DC)-to-DC Converter Unit (DDCU), Remote Power Controller Module (RPCM), and Crew Equipment Translation Aid (CETA) cart; secondary payloads of Spatial Heterodyne Imager for Mesospheric Radicals (SHIMMER) and Ram Burn Observation (RAMBO); first use of Shuttle Observation Camera System mounted to external tank

Extravehicular Activity (EVA) conducted by David Wolf and Piers Sellers from joint airlock "Quest" during three spacewalks for a total of 19 hours, 41 minutes EVA 1, 7 hours, 1 minute; after the S1 truss was lifted from Atlantis's cargo bay by the Canadarm2, operated by ISS crew member Peggy Whitson, and attached to the S0 truss, Wolf and Sellers attached power, data, and fluid lines between the S1 and S0, deployed the station's second S-band communications system, and installed the first of two external camera systems. EVA 2, 6 hours, 4 minutes; Wolf and Sellers set up a second camera system, released restraints on the CETA cart, and attached ammonia tank assembly cables. EVA 3, 6 hours, 36 minutes; Wolf and Sellers removed and replaced the Interface Umbilical Assembly on the station's Mobile Transporter and installed jumpers and spool positioning devices on the ammonia lines between the S1 and S0 trusses.

**STS-113 Mission Facts — Endeavour —
Nov. 23–Dec. 7, 2002**

Commander: James D. Wetherbee

Pilot: Paul S. Lockhart

Mission Specialist: Michael E. Lopez-Alegria

Mission Specialist: John B. Herrington

ISS Crew Member: Kenneth D. Bowersox—up only

ISS Crew Member: Nikolai M. Budarin, Russian Space Agency—up only

ISS Crew Member: Donald R. Pettit—up only

ISS Crew Member: Valeri G. Korzun, Russian Space Agency—down only

ISS Crew Member: Peggy A. Whitson—down only

ISS Crew Member: Sergei Y. Treschev, Russian Space Agency—down only

Launched: 7:49:47 p.m. EST, launch pad 39A, Kennedy Space Center, Fla.

Mission Duration: 312 hours (13 days), 18 hours, 47 minutes

Miles Traveled: Approximately 5.74 million statute miles

Orbits of Earth: 215

Inclination: 51.6 degrees

Orbital Altitude: 215 nautical miles

Liftoff Weight: 4,521,249 pounds

Orbiter Weight at Liftoff: 265,974 pounds

Payload Weight Up: 30,217 pounds

Payload Weight Down: 2,268 pounds

Orbiter Weight at Landing: 201,668 pounds

Landed: 2:37:12 p.m. EST, concrete runway 33, Kennedy Space Center, Fla.

Payload: ISS Assembly Flight 11A; 14-ton Port-One (P1) truss structure preintegrated with Ultra-high Frequency (UHF) communication equipment, Thermal Radiator Rotary Joint (TRRJ), three External Active Thermal Control System (EATCS) radiators, Direct Current (DC)-to-DC Converter Unit (DDCU), Remote Power Controller Module (RPCM), Nitrogen Tank Assembly (NTA), Ammonia Tank Assembly (ATA), and Pump Module Assembly (PMA); second Crew and Equipment Translation Aid (CETA) cart that can be manually operated along the Mobile Transporter rail line; Micro-Electromechanical System (MEMS)-Based Pico Satellite (PICOSAT) Inspector (MEPSI); fifth ISS crew exchange

Extravehicular Activity (EVA) conducted by Michael Lopez-Alegria and John Herrington from joint airlock “Quest” during three spacewalks for a total of 19 hours, 55 minutes ISS robot arm operators: Peggy Whitson, Ken Bowersox, and Don Pettit. Space shuttle robot arm operator: Jim Wetherbee. EVA 1, 6 hours, 45 minutes; after the P1 was attached to the station, Lopez-Alegria and Herrington started installing connections between the P1 and the S0 truss. They installed onto the Unity node the wireless video

STS-113 Mission Facts (Cont)

system external transceiver assembly, which will be used to support spacewalkers' helmet cameras. Herrington released launch restraints on the CETA cart. EVA 2, 6 hours, 10 minutes; Lopez-Alegria and Herrington installed another wireless video system external transceiver assembly onto the P1 and relocated the CETA cart from the P1 to the S1 truss, which will allow the mobile transporter to move along the P1 to assist in future assembly missions. EVA 3, 7 hours, 0 minute; Lopez-Alegria and Herrington installed additional Spool Positioning Devices, reconfigured electrical harnesses, and attached ammonia tank assembly lines.

STS-107 Mission Facts — Columbia — Jan. 16–Feb. 1, 2003

Commander: Rick D. Husband

Pilot: William C. McCool

Payload Commander: Michael P. Anderson

Mission Specialist: Kalpana Chawla

Mission Specialist: David M. Brown

Mission Specialist: Laurel B. Clark

Payload Specialist: Ilan Ramon, Israel

Launched: 10:39:00 a.m. EST, launch pad 39A, Kennedy Space Center, Fla.

Mission Duration: 360 hours (15 days), 22 hours, 21 minutes

Miles Traveled: Approximately 7.65 million statute miles

Orbits of Earth: 255

Inclination: 39 degrees

Orbital Altitude: 150 nautical miles

Liftoff Weight: 4,525,842 pounds

Orbiter Weight at Liftoff: 265,226 pounds

Payload Weight Up: 24,365 pounds

Payload: First flight of SPACEHAB as the SPACEHAB Research Double Module (SHRDM); Fast Reaction Experiments Enabling Science, Technology, Applications and Research (FREESTAR); first Extended Duration Orbiter (EDO) mission since STS-90. Mission dedicated to research in physical, life, and space sciences, conducted in approximately 80 experiments.

Loss of vehicle and crew during reentry, 9:00 a.m. EST

**STS-114 Mission Facts — Discovery —
July 26–Aug. 9, 2005**

Commander: Eileen M. Collins

Pilot: James M. Kelly

Mission Specialist: Soichi Noguchi, National Space Development Agency of Japan (JAXA)

Mission Specialist: Stephen K. Robinson

Mission Specialist: Andrew S.W. Thomas

Mission Specialist: Wendy B. Lawrence

Mission Specialist: Charles J. Camarda

Launched: 10:39:00 a.m. EDT, launch pad 39B, Kennedy Space Center, Fla.

Mission Duration: 312 hours (13 days), 21 hours, 33 minutes

Miles Traveled: Approximately 5.8 million statute miles

Orbits of Earth: 219

Inclination: 51.6 degrees

Orbital Altitude: Approximately 240 nautical miles

Liftoff Weight: 4,522,992 pounds

Orbiter Weight at Liftoff: 267,825 pounds

Payload Weight Up: 24,365 pounds

Payload Weight Down: 19,420 pounds

Orbiter Weight at Landing: 226,885 pounds

Landed: 5:12:36 a.m. PDT, concrete runway 22, Edwards Air Force Base, Calif.

Payload: ISS Assembly Flight LF1; first of two Return-to-Flight missions; Raffaello Multi-Purpose Logistics Module; test of orbiter boom sensor system (OBSS); test and evaluation of thermal protection system (TPS) repair techniques; replaced one ISS control gyroscope and restored power to a second gyroscope; installed External Stowage Platform 2 on ISS for future construction

Extravehicular Activity (EVA) conducted by Stephen Robinson and Soichi Noguchi during three spacewalks for a total of 20 hours, 5 minutes. EVA 1, 6 hours, 50 minutes; Robinson and Noguchi worked in Discovery's cargo bay with tiles and reinforced carbon-carbon intentionally damaged on the ground and brought into space to conduct tile repair and adhesive experiments. In addition, they installed a base and cabling for a stowage platform and rerouted power to Control Moment Gyroscope 2. EVA 2, 7 hours, 14 minutes; Robinson and Noguchi removed the failed Control Moment Gyroscope 1 and installed its replacement. EVA 3, 6 hours, 1 minute; attached to Canadarm2, Robinson was moved to Discovery's underside, where he pulled two protruding gap fillers from between thermal protection tiles. Robinson and Noguchi also installed an external stowage platform outside the ISS Quest airlock to house spare parts, and Noguchi installed a fifth Materials International Space Station Experiment (MISSE).

STS-114 Mission Facts (Cont)

Of Note: Before docking with the ISS, Collins performed the first Rendezvous Pitch Maneuver approximately 600 feet below the station. The motion flipped the shuttle end over end at 3/4 degree per second, allowing ISS crew members to photograph the underside of Discovery and its heat-resistant tiles in detail.

STS-121 Mission Facts — Discovery — July 4–17, 2006

Commander: Steven W. Lindsey

Pilot: Mark E. Kelly

Mission Specialist: Piers J. Sellers

Mission Specialist: Michael E. Fossum

Mission Specialist: Lisa M. Nowak

Mission Specialist: Stephanie D. Wilson

ISS Crew Member: Thomas Reiter, European Space Agency—up only

Launched: 2:38 p.m. EDT, launch pad 39B, Kennedy Space Center, Fla.

Mission Duration: 288 hours (12 days), 18 hours, 38 minutes

Miles Traveled: Approximately 5.3 million statute miles

Orbits of Earth: 202

Inclination: 51.6 degrees

Orbital Altitude: Approximately 185 nautical miles

Liftoff Weight: 4,523,850 pounds

Orbiter Weight at Liftoff: 267,001 pounds

Payload Weight Up: 29,280 pounds

Payload Weight Down: 24,508 pounds

Orbiter Weight at Landing: 225,715 pounds

Landed: 9:14 a.m. EDT, concrete runway 15, Kennedy Space Center, Fla.

Payload: ISS Assembly Flight ULF1.1; second Return-to-Flight mission; Leonardo Multi-Purpose Logistics Module carrying the Minus Eighty-Degrees Centigrade Laboratory Freezer for ISS (MELFI); Integrated Cargo Carrier (ICC); Lightweight Multi-Purpose Experiment Support Structure Carrier (LMC)

Extravehicular Activity (EVA) conducted by Piers Sellers and Michael Fossum during three spacewalks for a total of 21 hours, 29 minutes. EVA 1, 7 hours, 31 minutes; Sellers and Fossum installed a blade blocker in the zenith interface umbilical assembly to protect the power, data, and video cable, then rerouted the cable through the IUA so the mobile transporter rail car could be moved into position on the truss. In addition, they tested the capability of the space shuttle's robotic arm and its 50-foot extension—the orbiter boom sensor system—to act as a platform for spacewalkers making repairs. EVA 2, 6 hours, 47 minutes; Sellers and Fossum

STS-121 Mission Facts (Cont)

replaced the nadir-side trailing umbilical system (TUS) to restore the mobile transporter rail car to full operation and delivered a spare pump module for the ISS cooling system. EVA 3, 7 hours, 11 minutes; Sellers and Fossum tested techniques to inspect and repair damage to an orbiter's heat shield, including test of a repair material known as NOAX (non-oxide adhesive experimental), a pre-ceramic polymer sealant containing carbon-silicon carbide powder.

Of Note: Before docking with the ISS, Lindsey performed a 360-degree backflip approximately 600 feet below the station, allowing ISS crew members to photograph the underside of Discovery and its heat-resistant tiles in detail.

STS-115 Mission Facts — Atlantis — Sept. 9–21, 2006

Commander: Brent W. Jett

Pilot: Christopher J. Ferguson

Mission Specialist: Joseph R. Tanner

Mission Specialist: Daniel C. Burbank

Mission Specialist: Steven G. MacLean, Canadian Space Agency (CSA)

Mission Specialist: Heidemarie M. Stefanyshyn-Piper

Launched: 11:15 a.m. EDT, launch pad 39B, Kennedy Space Center, Fla.

Mission Duration: 264 hours (11 days), 19 hours, 6 minutes

Miles Traveled: Approximately 4.9 million statute miles

Orbits of Earth: 187

Inclination: 51.6 degrees

Orbital Altitude: Approximately 185 nautical miles

Liftoff Weight: 4,526,580 pounds

Orbiter Weight at Liftoff: 270,612 pounds

Payload Weight Up: 35,758 pounds

Payload Weight Down: 978 pounds

Orbiter Weight at Landing: 199,679 pounds

Landed: 6:21 a.m. EDT, concrete runway 33, Kennedy Space Center, Fla.

Payload: ISS Assembly Flight 12A; ITS P3 and P4, second port truss segment, second set of solar arrays and batteries. This addition added 45 feet to the ISS and increased the wingspan to more than 240 feet.

Extravehicular Activity (EVA) conducted by Heidemarie M. Stefanyshyn-Piper, Joe Tanner, Dan Burbank, and Steve MacLean during three spacewalks for a total of 20 hours, 19 minutes. EVA 1, 6 hours, 26 minutes; Piper and Tanner connected power cables on the truss and released the launch restraints on the solar array blanket box, beta gimbal assembly, and solar

STS-115 Mission Facts (Cont)

array wings. They also configured the solar alpha rotary joint (SARJ), an automobile-sized joint that allows the station's solar arrays to turn and point toward the Sun. EVA 2, 7 hours, 11 minutes; Burbank and MacLean devoted the spacewalk to the final tasks required for activation of the SARJ. EVA 3, 6 hours, 42 minutes; Piper and Tanner installed bolt retainers on the P6 beta gimbal assembly, which helps to orient the pitch of the solar array wings, and retrieved the Materials on the International Space Station Experiment 5.

Of Note: The shuttle critical systems, including its heat shield, were inspected three times during the mission using the orbiter boom sensor system, the 50-foot-long extension for the shuttle's robotic arm. In addition, a new procedure called a "camp out" was implemented in which astronauts slept in the Quest airlock prior to their spacewalks. The process shortens the "prebreathe" time during which nitrogen is purged from the astronauts' systems and air pressure is lowered to 10.2 psi so the spacewalkers avoid the condition known as "the bends". On each of the three spacewalks, the astronauts were able to perform more than the number of scheduled activities.

STS-116 Mission Facts — Discovery — Dec. 9–22, 2006

Commander: Mark L. Polansky

Pilot: William A. Oefelein

Mission Specialist: Robert L. Curbeam Jr.

Mission Specialist: Joan E. Higginbotham

Mission Specialist: Nicholas J.M. Patrick

Mission Specialist: Christer Fuglesang, European Space Agency (ESA)

ISS Crew Member: Sunita L. Williams—up only

ISS Crew Member: Thomas Reiter—down only

Launched: 8:47 p.m. EDT, launch pad 39B, Kennedy Space Center, Fla.

Mission Duration: 288 hours (12 days), 20 hours, 44 minutes

Miles Traveled: Approximately 5.3 million statute miles

Orbits of Earth: 204

Inclination: 51.6 degrees

Orbital Altitude: Approximately 185 nautical miles

Liftoff Weight: 4,520,334 pounds

Orbiter Weight at Liftoff: 265,275 pounds

Payload Weight Up: 35,720 pounds

Payload Weight Down: 3,705 pounds

Orbiter Weight at Landing: 225,431 pounds

STS-116 Mission Facts (Cont)

Landed: 5:32 p.m. EDT, concrete runway 15, Kennedy Space Center, Fla.

Payload: ISS Assembly Flight 12A.1; ITS P5, third port truss segment; SPACEHAB single cargo module; Integrated Cargo Carrier (ICC); Microelectromechanical System-Based PICOSAT Inspector (MEPSI) microsatellite; Radar Fence Transponder (RAFT) microsatellite; Atmospheric Neutral Density Experiment (ANDE) microsatellite; ISS crew exchange

Extravehicular Activity (EVA) conducted by Robert Curbeam, Christer Fuglesang, and Sunita Williams during four spacewalks for a total of 25 hours, 45 minutes. EVA 1, 6 hours, 36 minutes; Curbeam and Fuglesang attached the two-ton P5 segment, which had been unberthed the day before using the shuttle's robotic arm to remove it from the orbiter's payload bay and hand it off to the station arm. Guided by Curbeam and Fuglesang, Joan Higginbotham maneuvered the P5 into place. EVA 2, 5 hours, 0 minute; Curbeam and Fuglesang reconfigured two of the station's four power channels, channels 2 and 3. EVA 3, 7 hours, 31 minutes; Curbeam and Sunita Williams reconfigured the station's power channels 1 and 4, setting the stage for future installation of additional solar arrays and science modules, including those of international partners. EVA 4, 6 hours, 38 minutes; the P6 solar array wing had been extended in space for six years. The array panels would not fully retract because of a snagged guide wire, necessitating the addition of the fourth spacewalk to free the partially retracted solar array so it would fully fold. Curbeam and Fuglesang guided the P6 solar array wing inside its blanket box. Subsequently, the Solar Alpha Rotary Joint was powered up, enabling it to begin turning the P4 truss solar array wings, which had been installed in Sept. 2006, allowing the arrays to track the sun as it rises and sets with each station orbit.

Of Note: First nighttime launch in more than four years. Curbeam set a shuttle program record for the most spacewalks performed by one astronaut during a single mission. Mission Control sent approximately 17,900 commands during the mission, about 5,000 more commands than sent on any previous mission. First use of Advanced Health Management System (AHMS), developed at Marshall Space Flight Center to improve Space Shuttle Main Engine safety. AHMS was used on STS-116 to collect performance data only, but on future flights the AHMS will cut off an SSME if the AHMS detects that a failure is about to occur.

STS-117 Mission Facts — Atlantis —

June 8–22, 2007

Commander: Frederick W. Sturckow

Pilot: Lee J. Archambault

Mission Specialist: James F. Reilly II

Mission Specialist: Steven R. Swanson

Mission Specialist: Patrick G. Forrester

Mission Specialist: John D. (Danny) Olivas

ISS Crew Member: Clayton C. Anderson—up only

ISS Crew Member: Sunita L. Williams—down only

Launched: 7:38 p.m. EDT, launch pad 39A, Kennedy Space Center, Fla.

Mission Duration: 312 hours (13 days), 20 hours, 12 minutes

Miles Traveled: Approximately 5.8 million statute miles

Orbits of Earth: 219

Inclination: 51.6 degrees

Orbital Altitude: Approximately 220 nautical miles

Liftoff Weight: 4,525,519 pounds

Orbiter Weight at Liftoff: 270,517 pounds

Payload Weight Up: 42,671 pounds

Payload Weight Down: 1,057 pounds

Orbiter Weight at Landing: 199,501 pounds

Landed: 3:49 p.m. EDT, concrete runway 22, Edwards Air Force Base, Calif.

Payload: ISS Assembly Flight 13A; ITS S3 and S4, second starboard truss segment, the heaviest station payload the space shuttle has carried to date; third set of solar arrays and batteries; ISS crew exchange

Extravehicular Activity (EVA) conducted by James Reilly, Danny Olivas, Patrick Forrester, and Steve Swanson during four spacewalks for a total of 27 hours, 58 minutes. EVA 1, 6 hours, 15 minutes; previously, Lee Archambault and Patrick Forrester had used the shuttle's robotic arm to grapple the S3/S4 truss, lift it from its berth in the payload bay, and maneuver it for handover to the station's Canadarm2, manned by Sunita Williams. During their spacewalk, Reilly and Olivas focused on the final attachment of bolts, cables, and connectors to begin activation of the truss and ready it for deployment of its solar arrays. EVA 2, 7 hours, 16 minutes; Forrester and Swanson helped retract the 115-foot P6 solar array, which will be relocated during a future assembly mission, to clear the path for the new array, then removed all of the launch locks holding the solar alpha rotary joint in place, freeing it to rotate, enabling the new solar array wings on S4 to track the sun as ISS orbits the Earth. The arrays provide a total power capability of 60 kW, equivalent to the power used by 40 typical U.S. homes. EVA 3, 7 hours, 58 minutes; Reilly installed the hydrogen vent valve of a new oxygen generation system on the Destiny laboratory. Olivas completed a repair to a raised corner of a thermal insulation blanket that had come loose from the

STS-117 Mission Facts (Cont)

shuttle during launch. Olivas pressed down on the blanket and stapled one side of the 4- by 6-in. raised corner to an adjacent blanket. Olivas then pinned the other side of the blanket to a thermal tile. EVA 4, 6 hours, 29 minutes; Forrester and Swanson completed numerous tasks associated with the new truss segment, removed launch restraints on the SARJ to enable its rotation, and installed a debris shield on the Destiny laboratory.

Of Note: Following a hailstorm at KSC on Feb. 26, 2007, inspections of the stack found damage to the orbiter and the external tank. Hailstones as large as golf balls had damaged ice frost ramps on the tank, caused minor surface damage to about 26 heat shield tiles on Atlantis's left wing, and created more than 2,600 dents, divots, and gouges in the tank's foam insulation, requiring technicians to spray an aerodynamically smooth layer of thermal insulation on the curved portion near the top of the tank. Suni Williams set a new record of 194 days for the longest single spaceflight by a female space traveler, breaking the record of 188 days previously set by Shannon Lucid on her assignment aboard the Mir space station in 1996.

STS-118 Mission Facts — Endeavour — Aug. 8–21, 2007

Commander: Scott J. Kelly

Pilot: Charles O. Hobaugh

Mission Specialist: Dafydd (Dave) R. Williams, Canadian Space Agency

Mission Specialist: Barbara R. Morgan

Mission Specialist: Richard A. Mastracchio

Mission Specialist: Tracy E. Caldwell

Mission Specialist: Benjamin Alvin Drew

Launched: 6:36 p.m. EDT, launch pad 39A, Kennedy Space Center, Fla.

Mission Duration: 288 hours (12 days), 17 hours, 55 minutes

Miles Traveled: Approximately 5.3 million statute miles

Orbits of Earth: 202

Inclination: 51.6 degrees

Orbital Altitude: Approximately 184 nautical miles

Liftoff Weight: 4,520,773 pounds

Orbiter Weight at Liftoff: 268,574 pounds

Payload Weight Up: 23,899 pounds

Payload Weight Down: 12,385 pounds

Orbiter Weight at Landing: 222,398 pounds

Landed: 12:33 p.m. EDT, concrete runway 15, Kennedy Space Center, Fla.

STS-118 Mission Facts (Cont)

Payload: ISS Assembly Flight 13A.1; ITS S5, third starboard truss segment; External Stowage Platform 3 (ESP-3); SPACEHAB single cargo module

Extravehicular Activity (EVA) conducted by Richard Mastracchio, Dave Williams, and Clayton Anderson during four spacewalks for a total of 23 hours, 15 minutes. EVA 1, 6 hours, 17 minutes; Mastracchio and Williams attached the S5 segment of the station's truss and continued preparations to relocate the P6 truss. EVA 2, 6 hours, 28 minutes; Mastracchio and Williams replaced a faulty Control Moment Gyroscope (CMG), restoring the full four-CMG capability to help maintain ISS orientation. EVA 3, 5 hours, 28 minutes; Mastracchio and Anderson prepared the ISS for the next step in solar array deployment and voice communications system upgrades. The spacewalk ended early because of a perceived tear in Mastracchio's glove. EVA 4, 5 hours, 2 minutes; Williams and Anderson installed an External Wireless Instrumentation System antenna, installed a stand for the space shuttle's robotic arm extension boom, and retrieved two containers of the Materials ISS Experiment.

Of Note: The Zarya module, the oldest ISS element, completed its 50,000th orbit on Aug. 14. The Russian-built U.S. space station component's docking ports accommodate Russian Soyuz piloted spacecraft and unpiloted Progress resupply spacecraft.

In a first for the ISS, astronauts installed the ESP-3 using only the station and shuttle robotic arms. The installation of the two previous stowage platforms, one on *Destiny* and one on *Quest*, required the help of spacewalking astronauts.

First flight of *Endeavour* following a four-year modernization during which 1,670,000 parts were replaced and 194 modifications were made. STS-118 marked the first use of the Station-Shuttle Power Transfer System (SSPTS), a new system designed to allow a docked space shuttle to draw power from the ISS, which then enables a space shuttle to add three days to a mission. Future missions could gain as many as six extra days once all the ISS solar arrays are installed. Although STS-118 had the capability for a 14-day mission, the mission was ended one day early because of potential impacts at landing from Hurricane Dean.

Barbara Morgan, trained as the backup to Christa McAuliffe, NASA's Teacher in Space candidate, became the first Mission Specialist Educator in space on STS-118.

**STS-120 Mission Facts — Discovery —
Oct. 23–Nov. 7, 2007**

Commander: Pamela A. Melroy

Pilot: George D. Zamka

Mission Specialist: Scott E. Parazynski

Mission Specialist: Douglas H. Wheelock

Mission Specialist: Stephanie D. Wilson

Mission Specialist: Paolo A. Nespoli, European Space Agency (ESA)

ISS Crew Member: Daniel M. Tani—up only

ISS Crew Member: Clayton C. Anderson—down only

Launched: 11:38 a.m. EDT, launch pad 39A, Kennedy Space Center, Fla.

Mission Duration: 360 hours (15 days), 2 hours, 23 minutes

Miles Traveled: Approximately 6.25 million statute miles

Orbits of Earth: 238

Inclination: 51.6 degrees

Orbital Altitude: Approximately 210 nautical miles

Liftoff Weight: 4,524,107 pounds

Orbiter Weight at Liftoff: 268,177 pounds

Payload Weight Up: 33,813 pounds

Payload Weight Down: 2,020 pounds

Orbiter Weight at Landing: 202,138 pounds

Landed: 1:01 p.m. EST, concrete runway 33, Kennedy Space Center, Fla.

Payload: ISS Assembly Flight 10A; Node 2 connecting module; crew exchange

Extravehicular Activity (EVA) conducted by Scott Parazynski, Doug Wheelock, and Daniel Tani during four spacewalks for a total of 27 hours, 14 minutes. EVA 1, 6 hours, 14 minutes; Parazynski and Wheelock installed the Harmony module in a temporary location on the ISS and readied the P6 truss for its relocation. EVA 2, 6 hours, 33 minutes; Stephanie Wilson and Wheelock used Canadarm2 to grapple the P6 truss secured atop the Z1 truss. Parazynski and Tani teamed to disconnect cables from the P6, allowing it to be removed from the Z1 truss. Tani visually inspected the station's malfunctioning starboard Solar Alpha Rotary Joint (SARJ) and gathered samples of "shavings" he found under the joint's multilayer insulation covers for analysis. EVA 3, 7 hours, 8 minutes; Parazynski and Wheelock installed the P6 with its set of solar arrays at its permanent home. As the P6 solar arrays, which had been stowed during previous shuttle visits, were deployed, one experienced a tear in a blanket as it reached the 80% deployed point. EVA 4, 7 hours, 19 minutes; Parazynski, riding on the station's robot arm extended by the OBSS, cut snagged wires and installed array-stabilizing cuff links designed to strengthen the array's structures so it would not tear further. Parazynski took care to

STS-120 Mission Facts (Cont)

keep clear of the swaying array, occasionally dampening its motion with a prodder shaped like a hockey stick. Wheelock kept watch from the base of the solar array to ensure a safe distance was kept between Parazynski and the electrically charged solar array. After completion of the repairs, the crew was able to fully deploy the solar array.

Of Note: History was made with the meeting in space of Peggy Whitson, the first female commander of the ISS, and Pam Melroy, the second female commander of the space shuttle.

Parazynski's use of the Orbiter Boom and Sensor System (OBSS) during EVA 4 was the first operational use of the OBSS to reach a worksite.

STS-122 Mission Facts — Atlantis — Feb. 7–20, 2008

Commander: Stephen N. Frick

Pilot: Alan G. Poindexter

Mission Specialist: Rex J. Walheim

Mission Specialist: Stanley G. Love

Mission Specialist: Leland D. Melvin

Mission Specialist: Hans Schlegel, European Space Agency (ESA)

ISS Crew Member: Leopold Eyharts, ESA—up only

ISS Crew Member: Daniel M. Tani—down only

Launched: 2:45 p.m. EST, launch pad 39A, Kennedy Space Center, Fla.

Mission Duration: 288 hours (12 days), 18 hours, 22 minutes

Miles Traveled: Approximately 5.3 million statute miles

Orbits of Earth: 202

Inclination: 51.6 degrees

Orbital Altitude: Approximately 185 nautical miles

Liftoff Weight: 4,523,252 pounds

Orbiter Weight at Liftoff: 267,085 pounds

Payload Weight Up: 32,941 pounds

Payload Weight Down: 5,800 pounds

Orbiter Weight at Landing: 206,333 pounds

Landed: 9:07 a.m. EST, concrete runway 15, Kennedy Space Center, Fla.

Payload: ISS Assembly Flight 1E; Columbus Laboratory; crew exchange

Extravehicular Activity (EVA) conducted by Rex Walheim, Stanley Love, and Hans Schlegel during three spacewalks for a total of 22 hours, 8 minutes. EVA 1, 7 hours, 58 minutes; Walheim and Love installed a grapple fixture on Columbus while it rested inside the shuttle's payload bay and prepared electrical and data connections on Columbus. Leland Melvin, Dan Tani, and Leopold Eyharts operated the space

STS-122 Mission Facts (Cont)

station's robotic arm to grapple Columbus, lift it out of the orbiter, and attach it to the Harmony module on the starboard side of the ISS. EVA 2, 6 hours, 45 minutes; Walheim and Schlegel swapped out a 550-pound nitrogen tank used to pressurize ammonia through the station's main cooling system. EVA 3, 7 hours, 25 minutes; Walheim and Love transferred a failed gyroscope to the shuttle's payload bay for return to Earth, installed an observatory to the Columbus module called SOLAR to monitor the sun, and installed an experiment to the outside of Columbus, the European Technology Exposure Facility (EuTEF). This experiment will allow scientists to expose experiments to the vacuum and elements of space.

Of Note: The Columbus Laboratory is Europe's largest contribution to the construction of the ISS, adding 2,648 cubic feet of pressurized volume, four science experiment racks, and one storage rack. With this addition, the station has eight rooms and is 57 percent complete in terms of mass.

The landing of Atlantis occurred 46 years to the day since Mercury astronaut John Glenn was launched on an Atlas rocket to become the first American to orbit the Earth. Glenn made just three orbits in his single-seat Friendship 7 capsule.

STS-123 Mission Facts — Endeavour — March 11–26, 2008

Commander: Dominic L. Gorie

Pilot: Gregory H. Johnson

Mission Specialist: Richard M. Linnehan

Mission Specialist: Robert L. Behnken

Mission Specialist: Michael J. Foreman

Mission Specialist: Takao Doi, Japan Aerospace
Exploration Agency (JAXA)

ISS Crew Member: Garrett E. Reisman—up only

ISS Crew Member: Leopold Eyharts, ESA—down only

Launched: 2:28 a.m. EDT, launch pad 39A, Kennedy
Space Center, Fla.

Mission Duration: 360 hours (15 days), 18 hours,
11 minutes

Miles Traveled: Approximately 6.6 million statute miles

Orbits of Earth: 249

Inclination: 51.6 degrees

Orbital Altitude: Approximately 185 nautical miles

Liftoff Weight: 4,521,086 pounds

Orbiter Weight at Liftoff: 266,261 pounds

Payload Weight Up: 25,839 pounds

Orbiter Weight at Landing: 207,690 pounds

Landed: 8:39 p.m. EDT, concrete runway 15, Kennedy
Space Center, Fla.

STS-123 Mission Facts (Cont)

Payload: ISS Assembly Flight 1J/A; Kibo Japanese Experiment Logistics Module—Pressurized Section (ELM-PS) and Canadian Special Purpose Dexterous Manipulator; crew exchange

Extravehicular Activity (EVA) conducted by Rick Linnehan, Garrett Reisman, Mike Foreman, and Robert Behnken during five spacewalks for a total of 33 hours, 28 minutes. EVA 1, 7 hours, 1 minute; Linnehan and Reisman prepared the ELM-PS for removal from the space shuttle payload bay. Takao Doi used Canadarm to move the ELM-PS to its interim location on the zenith port of Harmony. The ELM-PS was relocated to its permanent location after the arrival of the Pressurized Module on space shuttle mission STS-124. Linnehan and Reisman also worked on the initial assembly of the Special Purpose Dexterous Manipulator, also known as “Dextre,” installing both orbital replacement unit/tool changeout mechanisms (OTCMs), the “hands” of Dextre’s arms. EVA 2, 7 hours, 8 minutes; Linnehan and Foreman attached the two arms of Dextre. EVA 3, 6 hours, 53 minutes; Linnehan and Behnken finished assembly and installation of Dextre. EVA 4, 6 hours, 24 minutes; the major focus of this spacewalk by Behnken and Foreman was a demonstration of the Tile Repair Ablator Dispenser, a caulk gun-like device. A substance called Shuttle Tile Ablator-54 (STA-54) was applied to intentionally damaged heat shield tiles, which were returned to Earth for testing to determine how STA-54 performed in both a microgravity and vacuum environment. EVA 5, 6 hours, 2 minutes; Behnken and Foreman installed the Materials International Space Station Experiment–6 (MISSE-6) and inspected the station’s right Solar Alpha Rotary Joint, where metal shavings had previously been discovered.

Of Note: A record five spacewalks were conducted during STS-123, also the longest mission to date at the ISS.

Because the Kibo Japanese Experiment Module—Pressurized Module (JEM–PM) that was launched on mission STS-124 is so large, the shuttle’s Orbiter Boom Sensor System (OBSS), the extension of the Canadarm that is usually carried in the shuttle’s cargo bay, was removed and stowed on the ISS. The OBSS was returned to Earth at the end of shuttle mission STS-124.

**STS-124 Mission Facts — Discovery —
May 31–June 14, 2008**

Commander: Mark E. Kelly

Pilot: Kenneth T. Ham

Mission Specialist: Karen L. Nyberg

Mission Specialist: Ronald J. Garan

Mission Specialist: Michael E. Fossum

Mission Specialist: Akihiko Hoshide, Japan Aerospace
Exploration Agency (JAXA)

ISS Crew Member: Gregory E. Chamitoff—up only

ISS Crew Member: Garrett E. Reisman—down only

Launched: 5:02 p.m. EDT, launch pad 39A, Kennedy
Space Center, Fla.

Mission Duration: 312 hours (13 days), 18 hours,
13 minutes

Miles Traveled: Approximately 5.7 million statute miles

Orbits of Earth: 217

Inclination: 51.6 degrees

Orbital Altitude: Approximately 185 nautical miles

Liftoff Weight: 4,525,084 pounds

Orbiter Weight at Liftoff: 269,123 pounds

Payload Weight Up: 33,969 pounds

Payload Weight Down: 1,687 pounds

Orbiter Weight at Landing: 203,320 pounds

Landed: 11:15 a.m. EDT, concrete runway 15, Kennedy
Space Center, Fla.

Payload: ISS Assembly Flight 1J; Japanese Experiment
Module—Pressurized Module (JEM-PM) and Japa-
nese Remote Manipulator System; crew exchange

Extravehicular Activity (EVA) conducted by Mike Fossum
and Ron Garan during three spacewalks for a total
of 20 hours, 32 minutes. EVA 1, 6 hours, 48 minutes;
Fossum and Garan prepared the Kibo JEM-PM for
installation on the ISS by disconnecting cables and
removing covers while Kibo was still in the shuttle's
payload bay. They also assisted with the transfer
of the Orbiter Boom Sensor System (OBSS) back
to the shuttle from the station, where it had been
stored since the last shuttle visit. EVA 2, 7 hours, 11
minutes; Fossum and Garan focused on external
outfitting of the new module, including installing
cameras that will help monitor external robotic and
payload operations. EVA 3, 6 hours, 33 minutes;
Fossum and Garan replaced a nitrogen tank as-
sembly (NTA) on the station's starboard truss. After
they detached the empty NTA, Garan rode the fully
extended Canadarm2 from the tank's installation
area to External Storage Platform-3, where it was
stored until its return on the STS-126 mission.

STS-124 Mission Facts (Cont)

Of Note: Karen Nyberg became the 50th woman in space and the first person to operate three robot arms—the station arm, the shuttle arm, and the Kibo arm. She and Akihiko Hoshide used the station’s arm to remove the JEM-PM from Discovery’s payload bay and latch it in place on the port side of the Harmony node. She and Greg Chamitoff later used the station’s arm to relocate the Japanese Experiment Logistics Module–Pressurized Section (ELM-PS) to its permanent home on top of the newly installed JEM-PM. Kibo’s JEM-PM is the largest shuttle payload delivered to the station to date and is now the largest pressurized module on the ISS.

STS-124 also marked the first time the JAXA flight control team activated and controlled a module from Kibo Mission Control in Tsukuba, Japan.

STS-126 Mission Facts — Endeavour — Nov. 14–30, 2008

Commander: Christopher J. Ferguson

Pilot: Eric A. Boe

Mission Specialist: Stephen G. Bowen

Mission Specialist: Donald R. Pettit

Mission Specialist: Robert S. Kimbrough

Mission Specialist: Heidemarie M. Stefanyshyn-Piper

ISS Crew Member: Sandra H. Magnus—up only

ISS Crew Member: Gregory Chamitoff—down only

Launched: 7:55 p.m. EST, launch pad 39A, Kennedy Space Center, Fla.

Mission Duration: 360 hours (15 days), 20 hours, 30 minutes

Miles Traveled: 6,615,109 statute miles

Orbits of Earth: 251

Inclination: 51.6 degrees

Orbital Altitude: Approximately 190 nautical miles

Liftoff Weight: 4,523,242 pounds

Orbiter Weight at Liftoff: 267,014 pounds

Payload Weight Up: 39,501 pounds

Payload Weight Down: 22,845 pounds

Orbiter Weight at Landing: 221,336 pounds

Landed: 4:25 p.m. EST, Edwards Air Force Base, Calif.

Payload: ISS Assembly Flight ULF2; Leonardo Multi-Purpose Logistics Module; crew exchange

Extravehicular Activity (EVA) conducted by Heidemarie Stefanyshyn-Piper, Stephen Bowen, and Robert Kimbrough during four spacewalks for a total of 26 hours, 41 minutes. EVA 1, 6 hours, 52 minutes; Piper and Bowen spent the majority of this spacewalk focusing on one of the station’s starboard Solar Alpha Rotary Joints (SARJ). These joints are

STS-126 Mission Facts (Cont)

the large, circular devices that allow the complex's solar arrays to automatically rotate and track the sun as the station orbits the Earth. Piper and Bowen cleaned and lubricated part of the joint and removed two of the joint's 12 trundle bearing assemblies (TBA). They also replaced a depleted nitrogen tank on a stowage platform outside the ISS. Additionally, they removed some insulation blankets from the common berthing mechanism on the Kibo laboratory. EVA 2, 6 hours, 45 minutes; Piper and Kimbrough continued to remove debris around the SARJ and apply lubrication, as well as replaced four more of the 12 TBAs. They also relocated two equipment carts in preparation for the installation of the final pair of solar arrays during space shuttle mission STS-119. EVA 3, 6 hours, 57 minutes; Piper and Bowen continued cleaning the starboard SARJ and replaced additional TBAs. EVA 4, 6 hours, 7 minutes; Bowen and Kimbrough installed the final TBA on the starboard SARJ and added lubrication to the port SARJ. They also retracted a berthing mechanism latch on the Kibo lab and reinstalled its thermal cover.

Of Note: Endeavour delivered equipment that will allow the station to double its crew size to six. The gear included two sleep stations, a new galley, a second bathroom, an advanced resistive exercise device, and a water recovery system that will allow urine and other condensate to be purified and converted into water for the crew's use.

Endeavour launched with the heaviest MPLM payload to date, carrying more than 1,000 items for the ISS. Because of the heavy payload, the MPLM was redesigned by Thales Alenia Space to enable it to carry an extra 600 pounds.

During this mission, the ISS celebrated the 10th anniversary since its construction began on Nov. 20, 1998, with the launch of the Zarya module.

STS-119 Mission Facts — Discovery — March 15–28, 2009

Commander: Lee J. Archambault

Pilot: Dominic A. Antonelli

Mission Specialist/Educator Astronaut: Joseph M. Acaba

Mission Specialist: Steven R. Swanson

Mission Specialist/Educator Astronaut: Richard R. Arnold II

Mission Specialist: John L. Phillips

ISS Crew Member: Koichi Wakata—up only

ISS Crew Member: Sandra H. Magnus—down only

Launched: 7:43 p.m. EDT, launch pad 39A, Kennedy Space Center, Fla.

STS-119 Mission Facts (Cont)

Mission Duration: 288 hours (12 days), 19 hours, 30 minutes

Miles Traveled: 5,304,140 statute miles

Orbits of Earth: 202

Inclination: 51.6 degrees

Orbital Altitude: Approximately 195 nautical miles

Liftoff Weight: 4,521,897 pounds

Orbiter Weight at Liftoff: 266,448 pounds

Payload Weight Up: 32,546 pounds

Payload Weight Down: 1,963 pounds

Orbiter Weight at Landing: 200,986 pounds

Landed: 3:15 p.m. EDT, concrete runway 15, Kennedy Space Center, Fla.

Payload: ISS Assembly Flight 15A; ITS S6, fourth starboard truss segment; fourth set of solar arrays and batteries; replacement distillation assembly for ISS water recycling system; crew exchange

Extravehicular Activity (EVA) conducted by Steven Swanson, Richard Arnold, and Joseph Acaba during three spacewalks for a total of 19 hours, 4 minutes. EVA 1, 6 hours, 7 minutes; Phillips and Magnus had previously used Canadarm2 to grapple S6, remove it from the shuttle payload bay, and position the S6 near the outboard end of the starboard truss. Swanson and Arnold then provided guidance to Phillips and Wakata for the final positioning of the S6 using Canadarm2, installed the S6 truss to the S5 truss, connected S5/S6 umbilicals, released launch restraints, removed keel pins, stored and removed thermal covers, and deployed the S6 photovoltaic radiator. EVA 2, 6 hours, 30 minutes; Swanson and Acaba performed advanced preparation of a work-site for STS-127, completed partial installation of an unpressurized cargo carrier attachment system on the P3 truss, and installed a Global Positioning System antenna to the Kibo laboratory. EVA 3, 6 hours, 27 minutes; Arnold and Acaba relocated a crew equipment cart, lubricated station arm grapple snares, and attempted deployment of a cargo carrier.

Of Note: With the installation of S6, the 335-foot-long truss is complete, and the ISS is 81 percent complete. The four pairs of solar arrays have a total surface area of 38,400 square feet, or 0.9 acre. The arrays now produce 120 kilowatts of usable electricity, doubling the previous amount available for science operations to 30 kilowatts.

**STS-125 Mission Facts — Atlantis —
May 11–24, 2009**

Commander: Scott D. Altman

Pilot: Gregory C. Johnson

Mission Specialist: Andrew J. Feustel

Mission Specialist: Michael T. Good

Mission Specialist: John M. Grunsfeld

Mission Specialist: Michael J. Massimino

Mission Specialist: K. Megan McArthur

Launched: 2:01 p.m. EDT, launch pad 39A, Kennedy
Space Center, Fla.

Mission Duration: 288 hours (12 days), 21 hours,
37 minutes

Miles Traveled: 5,276,000 statute miles

Orbits of Earth: 197

Inclination: 28.5 degrees

Orbital Altitude: 297 nautical miles

Liftoff Weight: 4,519,343 pounds

Orbiter Weight at Liftoff: 264,165 pounds

Payload Weight Up: 22,254 pounds

Payload Weight Down: 21,453 pounds

Orbiter Weight at Landing: 226,040 pounds

Landed: 11:39 a.m. EDT, concrete runway 22, Edwards
Air Force Base, Calif.

Payload: Hubble Space Telescope Servicing Mission 4
to repair and refurbish the orbiting observatory's
capabilities

Extravehicular Activity (EVA) conducted by John Grunsfeld, Andrew Feustel, Michael Good, and Michael Massimino during five back-to-back spacewalks for a total of 36 hours, 56 minutes. Megan McArthur used the Canadarm to grapple Hubble, maneuver it onto a flight support system maintenance platform in the shuttle's payload bay, and subsequently to release Hubble when the repairs were complete. EVA 1, 7 hours, 20 minutes; Grunsfeld and Feustel removed Wide-Field and Planetary Camera 2 and replaced it with Wide-Field Camera 3, which will allow Hubble to take extremely clear, detailed photos over a wider range of colors than WFPC2. Feustel struggled to loosen a bolt so he could remove WFPC2. Engineers on the ground theorized the low temperatures in space had altered the grease in the tool used to tighten the bolt during installation in 1993 and that more torque was needed to loosen the bolt than originally specified. The danger lay in shearing off the bolt, which would have made it impossible to remove WFPC2. Grunsfeld and Feustel also replaced the telescope's malfunctioning Science Instrument Command and Data Handling (SIC&DH) unit, which formats science data for transmission to Earth. EVA 2, 7 hours, 56 minutes; Good and Massimino replaced all three

STS-125 Mission Facts (Cont)

of Hubble's rate sensing units, each of which contains two gyroscopes. In addition, they replaced the battery module in Hubble's bay 2. EVA 3, 6 hours, 36 minutes; Grunsfeld and Feustel removed the refrigerator-size Corrective Optics Space Telescope Axial Replacement (COSTAR) installed in 1993 and then installed the new Cosmic Origins Spectrograph (COS). They also repaired the Advanced Camera for Surveys (ACS), one of Hubble's primary cameras, which had stopped working in 2007. The ACS was designed to operate in three modes: a high-resolution channel, a wide-field camera, and a so-called solar blind channel. Tests indicate the high-resolution channel was not restored. EVA 4, 8 hours, 2 minutes; Good and Massimino repaired the Space Telescope Imaging Spectrograph (STIS), which had ceased working in 2004, by replacing a power supply board. Massimino encountered a stripped bolt holding a handrail that needed to come off to reach the STIS, then had to unscrew more than 110 small fasteners to reach the STIS and not allow any of the fasteners to float away. EVA 5, 7 hours, 2 minutes; Grunsfeld and Feustel removed a battery module containing three batteries from bay 3 and replaced it with a fresh module. They also removed and replaced Fine Guidance Sensor (FGS) 2. In addition, Grunsfeld and Feustel installed New Outer Blanket Layers (NOBL) on three bays on the outside of the telescope. Hubble can go through temperature swings of a few hundred degrees every time it passes between daylight and darkness.

Of Note: Michael Massimino became the first person to use Twitter in space. Known among the Twittering crowd as Astro_Mike, he had been updating his more than 300,000 followers for two months prior to the mission. Massimino sent several tweets from orbit, though none while on a spacewalk.

For every shuttle mission since Columbia, there has been a contingency plan in place to allow another shuttle to be launched if needed to rescue a stranded shuttle crew. On ISS missions, a stranded crew can wait longer at the station than would have been the case for Atlantis. For STS-125, another shuttle was standing ready on Kennedy Space Center's launch pad 39B. If needed, space shuttle Endeavour, designated mission STS-400 and manned by the flight deck crew of mission STS-126, was ready to fly to Hubble and retrieve Atlantis's crew within days. Endeavour stayed on rescue stand-by until May 21, 2009.

STS-125 Mission Facts (Cont)

With the conclusion of the STS-125 mission, 23 spacewalks have been dedicated to Hubble, totaling 166 hours, 6 minutes. EVA 4 during STS-125 is the sixth longest spacewalk in U.S. history. EVA 2 is the ninth longest.

It took months to calibrate Hubble's systems so it could resume scientific observations, with astronomers focusing on stars of well-established brightness. Great care will be taken to keep the telescope from facing the Earth's blindingly bright reflection. The upgrades will extend its life to 2014, when a replacement, the James Webb Space Telescope, is scheduled for launch. It is estimated that around 2025, Hubble will begin to fall to Earth. A rocket will be launched with instruments that will robotically latch onto Hubble and guide it to a splashdown in the Pacific Ocean.

STS-127 Mission Facts — Endeavour — July 15–31, 2009

Commander: Mark L. Polansky

Pilot: Douglas G. Hurley

Mission Specialist: Christopher J. Cassidy

Mission Specialist: Thomas H. Marshburn

Mission Specialist: Julie Payette, Canadian Space Agency

Mission Specialist: David A. Wolf

ISS Crew Member: Timothy L. Kopra—up only

ISS Crew Member: Koichi Wakata—down only

Launched: 6:03 p.m. EDT, launch pad 39A, Kennedy Space Center, Fla.

Mission Duration: 360 hours (15 days), 16 hours, 45 minutes

Miles Traveled: 6,547,853 statute miles

Orbits of Earth: 248

Inclination: 51.6 degrees

Orbital Altitude: 191 nautical miles

Liftoff Weight: 4,519,002 pounds

Orbiter Weight at Liftoff: 264,198 pounds

Payload Weight Up: 24,638 pounds

Payload Weight Down: 10,479 pounds

Orbiter Weight at Landing: 214,747 pounds

Landed: 10:48 a.m. EDT, concrete runway 15, Kennedy Space Center, Fla.

Payload: ISS Assembly Flight 2J/A; Kibo Japanese Experiment Module Exposed Facility (JEM-EF), Kibo Japanese Experiment Logistics Module-Exposed Section (ELM-ES); Integrated Cargo Carrier (ICC); crew exchange

STS-127 Mission Facts (Cont)

Extravehicular Activity (EVA) conducted by David Wolf, Timothy Kopra, Thomas Marshburn, and Christopher Cassidy during five spacewalks for a total of 30 hours, 30 minutes. The spacewalkers were assisted by Mark Polansky and Julie Payette using the shuttle's Canadarm and Koichi Wakata and Douglas Hurley using the ISS Canadarm2. EVA 1, 5 hours, 32 minutes; Wolf and Kopra prepared the berthing mechanisms on the Kibo lab and the JEF for the installation. They also completed deploying an unpressurized cargo carrier attachment system on the P3 truss that had failed to unfurl during STS-119. EVA 2, 6 hours, 53 minutes; Wolf and Marshburn removed three hardware spares from an Integrated Cargo Carrier and attached them to a stowage platform on the P3 truss for long-term storage. EVA 3, 5 hours, 59 minutes; Wolf and Cassidy replaced two of six old solar array batteries on the P6 truss. These batteries were the oldest ones on the space station and were located at the end of the port side truss, hundreds of feet from the station's core. Each battery weighed 367 pounds and was the size of a refrigerator. It was originally planned to replace four batteries on EVA 3, but the spacewalk ended early when it appeared there was a potential problem with the carbon dioxide scrubbing device on Cassidy's spacesuit. EVA 4, 7 hours, 12 minutes; Cassidy and Marshburn replaced the remaining four solar array batteries on the P6 truss. EVA 5, 4 hours, 54 minutes; Cassidy and Marshburn installed video cameras on the front and back of the new JEM-EF, secured multilayer insulation around Dextre, split out power channels for two control moment gyroscopes, tied down cables, and installed handrails and a portable foot restraint.

Of Note: For the first time, 13 astronauts occupied the ISS at one time, the largest crew ever assembled on one space vehicle. All of the station's international partners—NASA, the Russian space agency Roscosmos, the European Space Agency (ESA), the Japan Aerospace Exploration Agency (JAXA), and the Canadian Space Agency (CSA)—were represented on board the ISS.

Mission specialist Christopher Cassidy became the 500th person in space.

Julie Payette and Robert Thirsk became the first two Canadians in space at the same time.

The crew of the ISS and space shuttle Endeavour honored the legacy of Apollo 11 by conducting a spacewalk on the same day that 40 years prior Neil Armstrong and Buzz Aldrin had walked on the moon for the first time.

STS-127 Mission Facts (Cont)

Two pairs of small research satellites—the Dual RF Astrodynamic GPS Orbital Navigation Satellite (DRAGONSat) and the Atmospheric Neutral Density Experiment–2 (ANDE-2)—were deployed from the space shuttle after it undocked from the ISS.

STS-128 Mission Facts — Discovery — Aug. 28–Sept. 11, 2009

Commander: Frederick W. Sturckow

Pilot: Kevin A. Ford

Mission Specialist: Patrick G. Forrester

Mission Specialist: José M. Hernández

Mission Specialist: Christer Fuglesang, European Space Agency (ESA)

Mission Specialist: John D. Olivas

ISS Crew Member: Nicole P. Stott—up only

ISS Crew Member: Timothy L. Kopra—down only

Launched: 11:59 p.m. EDT, launch pad 39A, Kennedy Space Center, Fla.

Mission Duration: 312 hours (13 days), 20 hours, 54 minutes

Miles Traveled: 5,755,275 statute miles

Orbits of Earth: 219

Inclination: 51.6 degrees

Orbital Altitude: 188 nautical miles

Liftoff Weight: 4,522,852 pounds

Orbiter Weight at Liftoff: 267,689 pounds

Payload Weight Up: 33,056 pounds

Payload Weight Down: 21,614 pounds

Orbiter Weight at Landing: 225,860 pounds

Landed: 8:53 p.m. EDT, concrete runway 22, Edwards Air Force Base, Calif.

Payload: ISS Assembly Flight 17A; Leonardo Multipurpose Logistics Module carrying more than 16,000 pounds of supplies and equipment, including the Combined Operational Load Bearing External Resistance Treadmill (COLBERT); Fluids Integrated Rack, Materials Science Research Rack–1 and Minus Eighty-Degree Laboratory Freezer for ISS; and new crew quarters for Robert Thirsk; Lightweight Multipurpose Carrier (LMC) with Ammonia Tank Assembly (ATA); crew exchange

Extravehicular Activity (EVA) conducted by Danny Olivas, Nicole Stott, and Christer Fuglesang during three spacewalks for a total of 20 hours, 15 minutes. EVA 1, 6 hours, 35 minutes; Olivas and Stott removed an ammonia tank assembly from the ISS port truss and two experiments—the European Technology Exposure Facility (EuTEF) and the Materials International Space Station Experiment (MISSE)—for return to Earth. EVA 2, 6 hours, 39 minutes; Olivas and Fuglesang installed a new ammonia tank assembly, which

STS-128 Mission Facts (Cont)

pushes ammonia through loops on the ISS truss to expel excess heat generated by the station's residents and systems, and installed a portable foot restraint for use during upcoming missions. EVA 3, 7 hours, 1 minute; Olivas and Fuglesang set up a payload attachment system on the ISS starboard truss to be used on STS-130; replaced a rate gyro assembly and remote power control module; installed two GPS antennas; and removed a slide wire on the Unity module.

Of Note: Astronaut José Hernández grew up in a migrant farming family and didn't learn English until he was 12. During his senior year of high school, listening to the radio while hoeing sugar beets, he learned that NASA had recruited its first Hispanic astronaut, Franklin Chang-Díaz. Inspired, Hernández decided to pursue his interests in math and science, eventually earning bachelor and master's degrees in electrical engineering. He formed the "Reaching for the Stars" foundation in his hometown of Stockton, Calif., to inspire local youth to excel in math, science, engineering, and technology. Hernández is NASA's first bilingual Twittering astronaut, sending Spanish and English tweets from Astro_Jose.

STS-129 Mission Facts — Atlantis — Nov. 16–27, 2009

Commander: Charles O. Hobaugh

Pilot: Barry E. Wilmore

Mission Specialist: Randolph J. Bresnik

Mission Specialist: Michael J. Foreman

Mission Specialist: Leland D. Melvin

Mission Specialist: Robert L. Satcher Jr.

ISS Crew Member: Nicole P. Stott—down only

Launched: 2:28 p.m. EST, launch pad 39A,
Kennedy Space Center, Fla.

Mission Duration: 240 hours (10 days), 19 hours,
16 minutes

Miles Traveled: 4,490,138 statute miles

Orbits of Earth: 171

Inclination: 51.6 degrees

Orbital Altitude: 191 nautical miles

Liftoff Weight: 4,522,269 pounds

Orbiter Weight at Liftoff: 266,310 pounds

Payload Weight Up: 29,372 pounds

Payload Weight Down: 2,933 pounds

Orbiter Weight at Landing: 205,420 pounds

Landed: 9:45 a.m. EST, concrete runway 33, Kennedy
Space Center, Fla.

STS-129 Mission Facts (Cont)

Payload: ISS Assembly Flight ULF3; deliver and integrate ExPRESS Logistics Carrier 1 and 2 (ELC1 and ELC2) carrying numerous orbital replacement units too big and massive to fly in any of the vehicles that will be left when the space shuttle retires, such as control moment gyroscopes, a battery charge discharge unit, a plasma contactor unit, nitrogen tanks, cooling system pump module assemblies, high-pressure gas tanks, ammonia tanks, a latching end effector for the station's robotics, and a trailing umbilical system reel assembly; Materials International Space Station Experiment (MISSE) 7; return ISS crew member Nicole Stott to Earth

Extravehicular Activity (EVA) conducted by Mike Foreman, Robert Satcher, and Randy Bresnik during three spacewalks for a total of 18 hours, 27 minutes. Leland Melvin and Randy Bresnik removed ELC1 from Atlantis's payload bay using the shuttle's robotic arm and handed it off to the station's robotic arm controlled by Barry Wilmore and ISS crew member Jeff Williams, who installed the carrier on the ISS P3 truss. ELC2 was installed on the ISS S3 truss using the station's robotic arm operated by Melvin and Nicole Stott. EVA 1, 6 hours, 37 minutes; Foreman and Satcher installed a spare S-band antenna assembly on the ISS Z1 truss, installed antenna cables on Destiny, replaced a handrail on Unity, and installed a Payload Attach System (PAS) on the Earth-facing side of the S3 truss. EVA 2, 6 hours, 8 minutes; Foreman and Bresnik installed the Grappling Adaptor to On-orbit Railing Assembly (GATOR) on a Columbus handrail, relocated the station's floating potential measurement unit to the P1 truss, installed a second PAS on the upper part of the S3 truss, deployed a third PAS on the S3 truss, and installed a wireless video system on S3. EVA 3, 5 hours, 42 minutes; Satcher and Bresnik installed a high-pressure oxygen tank that had been stored on ELC2 and subsequently placed by the Quest airlock by Melvin and Wilmore using the ISS robotic arm. Satcher and Bresnik also installed MISSE 7 on ELC2.

Of Note: While Randy Bresnik was busy with EVA 2, his wife, Rebecca, was busy on Earth giving birth to their daughter, Abigail Mae Bresnik, born Nov. 21, 2009, with an Earth weight of 6 pounds, 13 ounces. Abigail was born after her father completed his first spacewalk, during which time he was not in contact with the hospital. Bresnik is not the first astronaut to coach his wife through labor from orbit. Mike Fincke was on the ISS in 2004 when his wife gave birth to their daughter.

STS-129 Mission Facts (Cont)

For the first time, NASA invited its Twitter followers to sign up online for the chance to see a space shuttle launch in person. The 100 “tweeps,” who financed their own travel, represented 21 states plus the District of Columbia, as well as five countries, including Morocco and New Zealand. Astronauts have been tweeting from Earth and orbit since spring 2009, but this tweet-up was the first from Kennedy Space Center.

STS-130 Mission Facts — Endeavour — Feb. 8–21, 2010

Commander: George D. Zamka

Pilot: Terry W. Virts Jr.

Mission Specialist: Robert L. Behnken

Mission Specialist: Kathryn P. Hire

Mission Specialist: Nicholas J.M. Patrick

Mission Specialist: Stephen K. Robinson

Launched: 4:14 a.m. EST, launch pad 39A, Kennedy Space Center, Fla.

Mission Duration: 312 hours (13 days), 18 hours, 6 minutes

Miles Traveled: 5,738,991 statute miles

Orbits of Earth: 217

Inclination: 51.6 degrees

Orbital Altitude: 185 nautical miles

Liftoff Weight: 4,522,160 pounds

Orbiter Weight at Liftoff: 267,669 pounds

Payload Weight Up: 34,931 pounds

Payload Weight Down: 1,545 pounds

Orbiter Weight at Landing: 201,203 pounds

Landed: 10:20 p.m. EST, concrete runway 15, Kennedy Space Center, Fla.

Payload: ISS Assembly Flight 20A; Node 3 “Tranquility,” the final U.S. pressurized module; and the Cupola, a robotics work station with six windows around its sides and another in the center that provides a 360-degree view around the ISS

Extravehicular Activity (EVA) conducted by Robert Behnken and Nicholas Patrick during three spacewalks for a total of 18 hours, 14 minutes. Kathryn Hire and Terry Virts removed Tranquility from Endeavour’s payload bay using the station’s robotic arm and positioned it on the port side of the Unity module. Tranquility was then locked in place via 16 remotely controlled bolts. EVA 1, 6 hours, 32 minutes; Behnken and Patrick relocated a temporary platform from Dextre to the truss structure and installed two handles on Dextre. Once Tranquility was structurally mated to Unity, Behnken and Patrick connected heater and data cables to integrate

STS-130 Mission Facts (Cont)

Tranquility with the rest of the ISS systems. EVA 2, 5 hours, 54 minutes; Behnken and Patrick connected ammonia coolant loops, installed thermal covers around the ammonia hoses, outfitted the Earth-facing port on Tranquility for the relocation of its Cupola, and installed handrails and a vent valve on the new module. Hire and Virts subsequently moved the Cupola from its launch location to the Earth-facing side of Tranquility using Canadarm2. EVA 3, 5 hours, 48 minutes; Behnken and Patrick removed insulation blankets and launch restraint bolts from each of the Cupola's seven windows. They also installed handrails on Tranquility and relocated a foot restraint.

Of Note: Endeavour's 4:14 a.m. launch was the 34th night launch in shuttle history. Its 10:20 p.m. landing was even rarer, only the 17th night landing in the shuttle's three decades of service.

Zamka marked the Cupola's opening by presenting a plaque containing four chips from a moon rock and a fragment taken from Mt. Everest, the tallest mountain on Earth. The Everest rock was collected by astronaut Scott Parazynski in 2009 when he carried the moon rock pieces to the top of Mt. Everest. The moon rock samples were originally retrieved from the Sea of Tranquility during NASA's historic Apollo 11 mission, the first manned lunar landing, in July 1969. The new ISS module was named in honor of that mission.

STS-131 Mission Facts — Discovery — April 5–20, 2010

Commander: Alan G. Poindexter

Pilot: James P. Dutton Jr.

Mission Specialist: Richard A. Mastracchio

Mission Specialist: Dorothy M. Metcalf-Lindenburger

Mission Specialist: Clayton C. Anderson

Mission Specialist: Stephanie D. Wilson

Mission Specialist: Naoko Yamazaki, Japan Aerospace Exploration Agency (JAXA)

Launched: 6:21 a.m. EDT, launch pad 39A, Kennedy Space Center, Fla.

Mission Duration: 360 hours (15 days), 2 hours, 47 minutes

Miles Traveled: 6,232,235 statute miles

Orbits of Earth: 238

Inclination: 51.6 degrees

Orbital Altitude: 185 nautical miles

Liftoff Weight: 4,521,749 pounds

Orbiter Weight at Liftoff: 266,864 pounds

Payload Weight Up: 32,282 pounds

STS-131 Mission Facts (Cont)

Payload Weight Down: 23,619 pounds

Orbiter Weight at Landing: 224,957 pounds

Landed: 9:08 a.m. EDT, concrete runway 33, Kennedy Space Center, Fla.

Payload: ISS Assembly Flight 19A; Leonardo Multipurpose Logistics Module; Lightweight Multi-Purpose Experiment Support Structure Carrier (LMC)

Extravehicular Activity (EVA) conducted by Richard Mastracchio and Clayton Anderson during three spacewalks for a total of 20 hours, 17 minutes. EVA 1, 6 hours, 27 minutes; Mastracchio and Anderson moved a new ammonia tank for the station's cooling system from Discovery's cargo bay to a temporary parking place on the ISS. They also retrieved a seed experiment from the Kibo Laboratory Exposed Facility and replaced a rate gyro assembly on one of the truss segments. EVA 2, 7 hours, 26 minutes; Stephanie Wilson and James Dutton used Canadarm2 to move the spent ISS ammonia tank to one of the mobile equipment carts on the tracks of the ISS truss. Mastracchio and Anderson temporarily stowed the tank there until their third spacewalk. Wilson and Dutton then used Canadarm2 to retrieve the new tank from its temporary location on the Quest airlock, and Mastracchio and Anderson secured the tank in place. They also installed two radiator grapple fixture stowage beams on the P1 truss. EVA 3, 6 hours, 24 minutes; Wilson and Dutton used Canadarm2 to lift the depleted tank from its temporary storage location and moved it to Discovery's cargo bay. The depleted tank will be refurbished, refilled, and brought back to the ISS as a spare. Mastracchio and Anderson finished connecting fluid lines to the new ammonia tank and retrieved micrometeoroid shields from outside the airlock. Mastracchio also prepared cabling at the Z1 truss for installation of a communications antenna during the STS-132 mission.

Of Note: STS-131 was the final space shuttle mission to contain a "rookie" astronaut. The remaining missions will have all-veteran crews.

With three female crew members on board Discovery and Expedition 23 flight engineer Tracy Caldwell-Dyson at the ISS, the STS-131 mission marked the first time four women have been in space at the same time.

STS-131 marked the first time two Japanese astronauts—Naoko Yamazaki from the shuttle crew and Soichi Noguchi on the ISS—have been in space together. Yamazaki is the seventh Japanese astronaut to serve as a space shuttle crew member.

STS-131 Mission Facts (Cont)

Mastracchio and Anderson conducted a spacewalk together in Aug. 2007, with Mastracchio as a crew member of STS-118 and Anderson a member of ISS Expedition 15.

The 29th anniversary of the first space shuttle flight occurred on April 12, 2010, during the STS-131 mission.

STS-132 Mission Facts — Atlantis — May 14–26, 2010

Commander: Kenneth T. Ham

Pilot: Dominic A. Antonelli

Mission Specialist: Stephen G. Bowen

Mission Specialist: Michael T. Good

Mission Specialist: Piers J. Sellers

Mission Specialist: Garrett E. Reisman

Launched: 2:20 p.m. EDT, launch pad 39A, Kennedy Space Center, Fla.

Mission Duration: 264 hours (11 days), 18 hours, 29 minutes

Miles Traveled: Approximately 4,879,978 statute miles

Orbits of Earth: 186

Inclination: 51.6 degrees

Orbital Altitude: 190 nautical miles

Lift-Off Weight: 4,519,769 pounds

Orbiter Weight at Lift-Off: 263,100 pounds

Payload Weight Up: 26,615 pounds

Payload Weight Down: 7,685 pounds

Orbiter Weight at Landing: 209,491 pounds

Landed: 8:48 a.m. EDT, concrete runway 33, Kennedy Space Center, Fla.

Payload: ISS Assembly Flight ULF4; Integrated Cargo Carrier (ICC); Mini-Research Module 1 (MRM1); last shuttle delivery of an ISS module

Extravehicular Activity (EVA) conducted by Garrett Reisman, Stephen Bowen, and Michael Good during three spacewalks for a total of 21 hours, 20 minutes. EVA 1, 7 hours, 25 minutes; Reisman and Bowen installed a second antenna for high-speed Ku-band transmissions and added a spare parts platform to Dextre. They also loosened bolts holding six replacement batteries in preparation for the second and third spacewalks. EVA 2, 7 hours, 9 minutes; Bowen and Good changed out four of the six 375-pound batteries on the P6 truss. EVA 3, 6 hours, 46 minutes; Reisman and Good installed the last two batteries on the P6 truss.

STS-132 Mission Facts (Cont)

Of Note: The Russian MRM1 was installed robotically, without the aid of spacewalkers. Ham and Antonelli used the shuttle's Canadarm to unberth the module from Atlantis's payload bay and handed it off to the ISS's Canadarm2. Reisman and Sellers used Canadarm2 and guided the docking probe of MRM1 into the Earth-facing port on the Zarya module.

On board Atlantis was a four-inch-long wood sample of Sir Issac Newton's apple tree. The piece from the original tree that supposedly inspired Newton's theory of gravity, along with a picture of Newton, was taken into orbit by Piers Sellers. The wood is part of the collection of the Royal Society archives in London and was returned there following the flight.

UPCOMING SPACE SHUTTLE MISSIONS

STS-133 Flight Crew

Commander: Steven W. Lindsey (fifth flight)

Pilot: Eric A. Boe (second flight)

Mission Specialist: Benjamin Alvin Drew Jr. (second flight)

Mission Specialist: Michael R. Barratt (second flight)

Mission Specialist: Timothy L. Kopra (third flight)

Mission Specialist: Nicole P. Stott (third flight)

Payload: ISS Assembly Flight ULF5; Pressurized Multi-purpose Module (PMM); Robonaut2; ExPRESS Logistics Carrier 4 (ELC4)

Projected launch date is November 2010, with Discovery (OV-103) in its 39th and final flight

STS-134 Flight Crew

Commander: Mark E. Kelly (fourth flight)

Pilot: Gregory H. Johnson (second flight)

Mission Specialist: E. Michael Fincke (third flight)

Mission Specialist: Roberto Vittori, European Space Agency (ESA) (third flight)

Mission Specialist: Andrew J. Feustel (second flight)

Mission Specialist: Gregory E. Chamitoff (third flight)

Payload: ISS Assembly Flight ULF6; Alpha Magnetic Spectrometer (AMS); ExPRESS Logistics Carrier 3 (ELC3)

Projected launch date is February 2011, with Endeavour (OV-105) in its 25th and final flight

Of Note: Commander Mark Kelly's identical twin brother, Scott Kelly, arrived at the space station on Oct. 9, 2010, to serve as ISS Expedition 25 flight engineer and commander of Expedition 26. Because of the fluidity of launch schedules, the two may meet in space.

STS-135 Flight Crew

Commander: Christopher J. Ferguson (third flight)

Pilot: Douglas G. Hurley (second flight)

Mission Specialist: Sandra H. Magnus (fourth flight)

Mission Specialist: Rex J. Walheim (third flight)

Payload: ISS resupply mission; Multi-purpose Logistics Module (MPLM) Raffaello; Lightweight Multi-Purpose Carrier (LMC)

Projected launch date is June 2011, with Atlantis (OV-104) in its 33rd and final flight

Of Note: Smallest shuttle crew since STS-6 in April 1983

Last flight of the Space Shuttle Program





Photos courtesy of NASA and ESA

The STS-133 Reporter's Space Flight Notepad
was produced by Creative Services in
Huntington Beach, Calif.

Writer/Editor:	Bernadette Coleman
Layout:	Christine Guerrero
Graphics:	Reginald Morris



Boeing in Space

The Boeing Company's human space flight legacy spans more than 50 years, including development of the massive Saturn V rocket and Apollo Command/Service Module that carried the first humans to the moon and back to Earth, development and maintenance of the versatile space shuttle, and as the lead contractor for the International Space Station—planet Earth's permanent orbital outpost.

NASA plans to extend the life of the ISS to at least 2020. The labs have great potential to benefit mankind in medical research, research on materials, and as an Earth observation platform. As the prime contractor for the ISS, Boeing looks forward to the opportunity to continue working with NASA and the international partner government agencies to maximize its utility for the benefit of all mankind. In the same way that Boeing helped launch commercial aviation decades ago, Boeing is working to develop what could become a true commercial space transportation system: a commercial service to take crew to the ISS and other destinations.

Boeing is teamed with Bigelow Aerospace to develop a reusable commercial space capsule that will be compatible with multiple launch vehicles and configurable to carry a mixture of crew and cargo on missions to the ISS and other future destinations in low Earth orbit, leading the way for the next bold step in human space flight.

